

John Deere Catalog

Parts, Equipment, Supplies, and More



JOHN DEERE

Harvest 2024



DISCOUNTED PRICING
ON HUNDREDS OF ITEMS.

LIMITED-TIME
SUPER DISCOUNTS!

#H127035 – **\$2.06** Reel Fingers
#AH153175 – **\$3.00**

Reel fingers are made out of a unique high-strength poly that increases the stiffness of the fingers for increased strength.

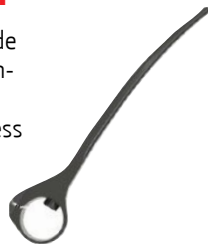

Page 12

\$16.58 Chisel Point

2-inch x 16-inch chisel point made of high-carbon steel for long-life and superior performance.
#N130190



Page 55

\$10 Mail-in Rebate
Hand-Carry Toolboxes, 20-in.

\$10 Mail-in Rebate with purchase of a 20-in. Hand-Carry Toolbox – #HR-20HB-1 or #HR-20HB-2.



HR-20HB-1



HR-20HB-2

Page 90

Rewards



JOHN DEERE

EXCLUSIVE MEMBER OFFERS ARE THE

BEST PART.

Platinum Rewards members earn additional discounts on parts as well as machines and the John Deere Store, and receive Home and Workshop rebates. Add affiliations to upgrade your Rewards membership and unlock additional John Deere discounts.

Learn more about the many ways to save money with John Deere Rewards. Visit [JohnDeere.com/Rewards](https://www.johndeere.com/Rewards)



FEEL THE CONFIDENCE

KNOW YOU GOT

THE RIGHT PART.

Run with us. Where your best interests matter the most. Here, you'll always land the right part at the right price for your machine. Have complete confidence in the part and the partner with every purchase.



**PARTS AVAILABLE
IN STORE OR ONLINE.**

Shop.Deere.com

INTRODUCING | USED POWERGARD™ EXTENDED WARRANTY PROTECTION



SOMETHING NEW FOR SOMETHING USED

Your used machine can go from “no warranty” to “under warranty” with Used PowerGard¹ from John Deere. Created specifically for **out-of-warranty, customer-owned machines** (see disclaimer), Used PowerGard – an Inspect & Protect Program – helps to maintain the performance of your older equipment for years ahead. This limited engine-and-powertrain warranty is for used John Deere machines, including:

- Tractors
- Combines
- Sprayers
- Nutrient Applicators
- Cotton Harvesters
- Windrowers
- Self-Propelled Forage Harvesters

Choose from a variety of **flexible terms**, in total months and total hours, and **low-cost deductibles**. Used PowerGard is also available for used machines purchased from participating dealers.

Get peace of mind today. Get Used PowerGard

¹Qualified customer-owned equipment for a Used PowerGard Plan is limited to tractors **under 10 years old** and **under 5,000 hours** and to combines, sprayers, self-propelled forage harvesters, cotton harvesters and windrowers **under 7 years old** and **under 2,000 hours**. To be eligible for Used PowerGard, your out-of-warranty equipment is subject to certification which includes inspection and fluid sampling. See your participating John Deere dealer for complete details.

JohnDeere.com/PowerGard



Get the Parts you need. And more.

Need parts, attachments, and maintenance items for your machines? What about tools or supplies for your shop? Find it all at your local John Deere dealership and online at Shop.Deere.com.

Start shopping now by browsing through this issue of the Parts Catalog. You'll discover valuable products to enhance your operation along with special offers to improve your bottom line.

And with Shop.Deere.com, you can have many orders delivered right to your doorstep. Now that's convenience at its best.



CONTENTS	
Combine Parts & Attachments	8–27
Precision Ag	28–29
Tractor Parts & Attachments	30–39
Engine & Reman Parts	40–44
Bearings	46
Cotton Picker Parts & Attachments	Cot 1–8
Forage Harvester Parts & Attachments	FH 1–8
Hay & Forage Parts & Attachments	47–52
Tillage Parts	53–56
Air Seeder & Drill Parts	57–61
Sprayer Parts & Attachments	63–66
Hoses & Hydraulic Parts	67–68
Filters & Fleetguard®	69–70
Oil & Lubricants	71–74
Batteries & Chargers	75–77
Accessories	78–79
Turf & Utility Vehicle Parts & Attachments	80–83
Chemicals & Paint	84–85
Home & Workshop Products	86–90

To change your address, send your old address label along with your new address to:

John Deere
c/o Customer Mail
P.O. Box 417
Moline, IL 61266-0417

Prices are suggested retail prices only and are subject to change without notice at any time. Dealer may sell for less. Taxes, setup, delivery, freight, and preparation charges not included. See dealer for details.

**Manufacturer's limited warranty. Limitations apply and vary by model. See manufacturer for details.

††The engine horsepower information is provided by the engine manufacturer to be used for comparison purposes only. Actual operating horsepower will be less.

*Trademark is third party used with permission.

John Deere, the leaping deer symbol and John Deere's green and yellow trade dress are the trademarks of Deere & Company.

BUNDLE 'N' SAVE

- Augers
- Chopper Knives
- Concaves
- Draper Belts
- Knife Guards
- Knife Sections
- Separator Tines
- Threshing Elements

Saving on combine parts is as easy as 1-2-3. Jump on this limited-time offer before you roll out your combine for harvest.

PICK
3

OR MORE COMBINE
PARTS CATEGORIES

PURCHASE
\$300

MINIMUM OF PARTS
IN EACH CATEGORY

GET
15%¹

OFF ALL PARTS IN
YOUR SELECTED CATEGORIES

Feel Confident. See Value. Own Choice.

Offer ends 8/31/24. Inquire today!

¹Get 15% off Genuine John Deere combine parts when you purchase \$300 or more in at least 3 of the 8 combine parts categories (augers, concaves, draper belts, knife guards, knife sections, separator tines, chopper knives, threshing elements) from a participating U.S. John Deere dealer between May 1, 2024 and August 31, 2024. \$300 worth of parts before applicable taxes must be purchased in at least 3 categories to receive 15% OFF. Offer not valid on previously purchased parts or attachments nor on attachment ordered as an option code. Offer has no cash value and cannot be redeemed for cash. Dealer participation may vary. Other restrictions may apply. See your John Deere dealer for details.

Gathering Chains

Features of Genuine John Deere Chains:

- The face of each flight is extended down to create a lip between sidebars— this prevents debris from collecting at the roller and reduces wear on the chain and sprockets
- The flight face slants at a 15-degree angle away from roller chains to create a self-cleaning effect as the flight moves ears towards the auger
- Chains are coated with a rust-preventative chain lubricant



NUMBER	DESCRIPTION	TYPE	LIST	NOW
40 and 90 Series:				
AN102009	Black Pin Gathering Chain	John Deere	\$ 63.60	\$58.51
A-AN102009	Black Pin Gathering Chain	A&I Products	\$ 66.40	
600 Series (MY08–11) (-745100):				
AH208978	Chrome Pin Gathering Chain	John Deere	\$104.04	\$95.72
600 Series (MY12–17) (745100-):				
AXE61091	Chrome Pin Gathering Chain	John Deere	\$105.17	\$96.76

Gathering Chain Sprockets

Gathering chain sprockets need to be inspected and replaced as needed. It is a good practice to replace the sprockets when replacing the gathering chains. Corn heads have an upper drive sprocket and lower idler sprocket.



NUMBER	DESCRIPTION	TYPE	LIST	NOW
40 Series:				
H85252	Upper Drive Sprocket	John Deere	\$25.10	\$23.09
A-H85252	Upper Drive Sprocket	A&I Products	\$15.52	
AN102448	Lower Idler Sprocket (-466449)	John Deere	\$21.90	\$20.15
AH101219	Lower Idler Sprocket (466450-)	John Deere	\$21.63	\$19.90
A-AH101219	Lower Idler Sprocket (466450-)	A&I Products	\$17.58	
90 Series:				
H85252	Upper Drive Sprocket	John Deere	\$25.10	\$23.09
A-H85252	Upper Drive Sprocket	A&I Products	\$15.52	
AH101219	Lower Idler Sprocket	John Deere	\$21.63	\$19.90
A-AH101219	Lower Idler Sprocket	A&I Products	\$17.58	
600 Series (MY08–11) (-745100)				
H233287	Upper Drive Sprocket	John Deere	\$52.68	\$48.47
A-H233287	Upper Drive Sprocket	A&I Products	\$42.65	
AH231386	Lower Idler Sprocket	John Deere	\$47.39	\$43.60
A-AH231386	Lower Idler Sprocket	A&I Products	\$42.08	
600 Series (MY12–17) (745100-):				
AXE36872	Upper Drive Sprocket	John Deere	\$69.31	\$63.77
A-AXE36872	Upper Drive Sprocket	A&I Products	\$44.44	
AXE63766	Lower Idler Sprocket	John Deere	\$48.19	\$44.33
A-AXE18770	Lower Idler Sprocket	A&I Products	\$38.14	

RETOOL WITH

ROWMAX

STALK DEFLECTOR



CHAIN KIT



STALK ROLLS (2)



Scan for more information
about Stalk Deflector
Installation

Why trade when you can upgrade your cornhead with RowMax. Our performance aftermarket upgrade extends the life of the row units on your John Deere 600C/FC or 700C/FC cornhead (MY12 or newer). Along with an **advanced gathering chain** that features 12 additional links, two more sprocket teeth and upgraded alloy bushings, Add on stalk deflectors to reduce damage to tires and tracks. New poly skid attachment can be attached to stalk deflectors to extend wear life. Plus, you get your choice of stalk rolls: straight fluted, opposed knife, intermeshing knife or **chopping stalk roll**.

JohnDeere.com/CombineParts

NUMBER	DESCRIPTION	LIST	NOW
BXE11362	Stalk Deflector ¹	\$775.50	\$713.46
BXE11424	NEW PolySkid Attachment	\$ 49.50	\$ 45.54
KXE10487	RowMax Gathering Chain Kit ²	\$473.33	\$435.46
HXE184546	LH Opposed Stalk Roll	\$454.39	\$418.04
HXE184547	RH Opposed Stalk Roll	\$454.39	\$418.04
HXE184548	LH Intermeshing Stalk Roll	\$417.45	\$384.05
HXE184549	RH Intermeshing Stalk Roll	\$445.27	\$409.65
HXE141569	LH Chopping Stalk Roll	\$772.73	\$710.91
HXE141570	RH Chopping Stalk Roll	\$772.73	\$710.91

¹For installing Stalk Deflector on 600/700 Series heads, also order 4 HXE156717 stud bolts per row.

²Also order KXE10528 metal guide kit to complete first time installation for RowMax™ Kit KXE10487.

Row Unit Gear Cases

Complete gear cases are available when one goes down. Choose from different options including John Deere, John Deere Reman, and A&I Products.

NUMBER	DESCRIPTION	TYPE	LIST	NOW
40 and 90 Series:				
PG200881	Gear Case	John Deere Reman	\$2,426.54	\$2,232.42
A-AH209794	Gear Case	A&I Products	\$1,927.85	
600 Series (-745100):				
DE30417	Gear Case	John Deere	\$4,928.51	\$4,534.23
600 Series (745100-785000):				
DE30812	Gear Case	John Deere	\$4,409.60	\$4,056.83
600 Series (785001-):				
DE31189	Gear Case	John Deere	\$3,746.42	\$3,446.71



A-AH209794

Row Unit Slip Clutches

NUMBER	DESCRIPTION	TYPE	LIST	NOW
40- and 90-Series:				
AH146250	Slip Clutch	1 1/8" Hex Shaft	\$ 347.54	\$ 319.74
AH209784	Slip Clutch	1 1/4" Hex Shaft	\$ 312.93	\$ 287.90
600-Series (-745100)::				
AH218768	Slip Clutch	Without StalkMaster™	\$ 298.41	\$ 274.54
KXE10109	Slip Clutch with Hardware	With StalkMaster™	\$ 898.61	\$ 826.72
AXE19434	Slip Clutch	With StalkMaster™	\$ 990.65	\$ 911.40
600-Series (745100-785000)				
AXE50867	Slip Clutch	Without StalkMaster™	\$ 516.74	\$ 475.40
AXE53653	Slip Clutch	With StalkMaster™	\$ 779.77	\$ 717.39
600-Series (785001-):				
AXE50867	Slip Clutch	Without StalkMaster™	\$ 516.74	\$ 475.40
AXE44461	Slip Clutch	With StalkMaster™	\$1,199.64	\$1,103.67

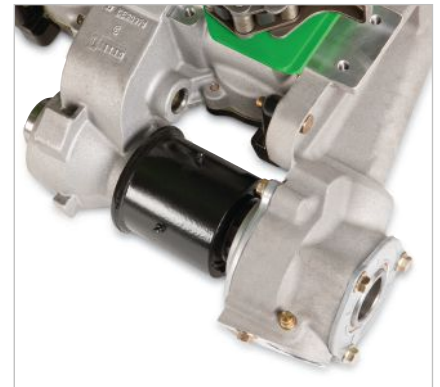

StalkMaster™ Blades

When replacing the StalkMaster™ blades make sure to inspect and replace the bushings as well.

NUMBER	DESCRIPTION	TYPE	LIST	NOW
600 Series (-745100):				
HXE36504	Blade	John Deere	\$33.90	\$31.19
H233284	Blade Bushing	John Deere	\$13.38	\$12.31
A-H233284	Blade Bushing	A&I Products	\$ 9.08	
600 Series (745101-):				
HXE36504	Blade	John Deere	\$33.90	\$31.19
HXE24237	Blade Bushing	John Deere	\$16.42	\$15.11
A-HXE24237	Blade Bushing	A&I Products	\$10.76	



Trash Deflector

NUMBER	DESCRIPTION	TYPE	LIST	NOW
600 Series (-745100):				
H227244	Deflector		\$110.47	\$101.63
600 Series (745100-):				
AXE18146	Deflector	30", 36", 38"	\$259.03	\$238.31
AXE47158	Deflector	20", 22"	\$235.67	\$216.82



Platform Parts

Innovative Engineering

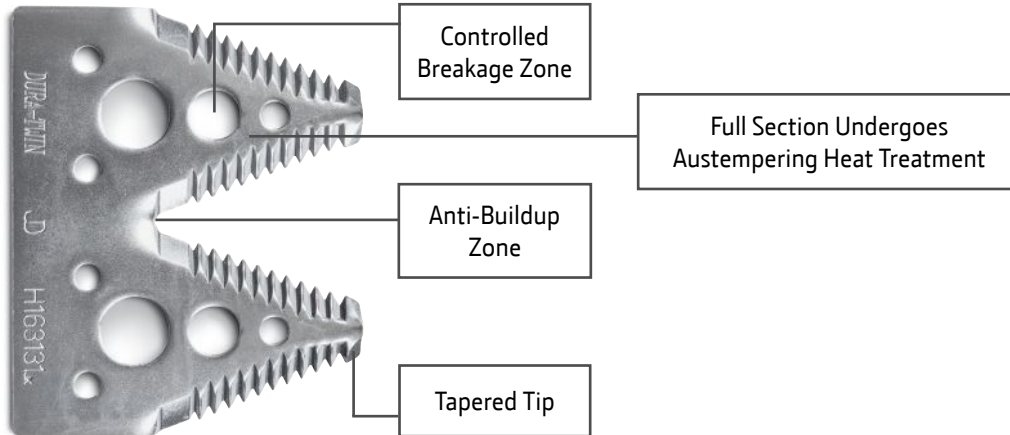

John Deere sickle sections are engineered for maximum performance.

- The tapered tip and consistent serrations maintain sharpness
- The anti-buildup zone reduces clogging and increases capacity
- The innovative breakage zone allows the section to break, rather than bend, without damaging guards—all while reducing overall cutterbar weight
- Austempering heat treatment gives the entire section strength and balanced wear

Sections

Fine-Tooth Sections – Recommended for small grains.

Coarse-Tooth Sections – Recommended for green-stemmed crops like soybeans.

No-Till Sections – Recommended in no-till conditions to prevent corn stalks from pinching.



Dura-Twin



No-Till Section



Dura-Lite

NUMBER	DESCRIPTION	TYPE	LIST
900, 900F, 900R Series – 3" Cutting Systems:			
H207929	Dura-Lite Fine-Tooth	John Deere	\$2.12
H207930	Dura-Lite Coarse-Tooth	John Deere	\$2.12
600/700 Series – 4" Cutting Systems, Dura-Twin Sections:			
H153329	Fine-Tooth	John Deere	\$3.41
A-H153329	Fine-Tooth	A&I Products	\$2.56
H163131	Coarse-Tooth	John Deere	\$3.22
A-H163131	Coarse-Tooth	A&I Products	\$2.38
600/700 Series – 4" Cutting Systems, No-Till sections, Short/Long:			
H215025	Fine-Tooth	John Deere	\$4.00
H215064	Coarse-Tooth	John Deere	\$4.00
A-H215064	Coarse-Tooth	A&I Products	\$3.02



Don't discount your guards

Only replacing your knives is like sharpening one side of your scissors. A dull edge on your guards can sacrifice cut quality and potentially force you to run slower...costing acres per hour.

John Deere offers green, high-wear guards that come standard from the factory. These guards go through an added boronization process that gives them twice the wear life compared with the standard black guards. If your conditions don't require that added wear life, the standard, black guards are case hardened all the way around. This provides a longer wear life compared to some aftermarket guards that are only induction hardened at the corners of the cutting edge.

Make sure you're using the right cutting system for your primary crop.

- Long-point guards and fine tooth sections – small grains
- Blunt-point guards and coarse-tooth sections – soybeans
- No-till sections and guards – to help prevent corn stalks from hairpinning

Visit JohnDeere.com/CombineParts to learn more.



Scan for more information

Guards

NUMBER	DESCRIPTION	TYPE	LIST
900, 900F, 900R Series:			
H145791	Green, Standard Heat Treated	John Deere	\$13.09
H153719	Silver, Double Heat Treated	John Deere	\$16.18
600 Series – Long Point (Small Grains):			
H213508	Black, Standard (Short-Long-Short)	John Deere	\$19.91
H213405	Black, Standard (Long-Short-Long)	John Deere	\$19.19
H229540	Green, High Wear (Short-Long-Short)	John Deere	\$27.00
A-H229540	High Wear (Short-Long-Short)	A&I Products	\$17.80
H229539	Green, High Wear (Long-Short-Long)	John Deere	\$27.00
A-H229539	High Wear (Long-Short-Long)	A&I Products	\$16.11
600 Series – Blunt Point (Coarse Grains):			
H213507	Black, Standard (Short-Long-Short)	John Deere	\$19.15
H213398	Black, Standard (Long-Short-Long)	John Deere	\$19.09
H229538	Green, High Wear (Short-Long-Short)	John Deere	\$27.00
A-H229538	High Wear (Short-Long-Short)	A&I Products	\$14.67
H229537	Green, High Wear (Long-Short-Long)	John Deere	\$27.00
A-H229537	High Wear (Long-Short-Long)	A&I Products	\$14.67
600 Series – No-Till Blunt Point (Coarse Grains):			
H218701	Green, High Wear (Short-Long-Short)	John Deere	\$22.14
H218702	Green, High Wear (Long-Short-Long)	John Deere	\$22.14

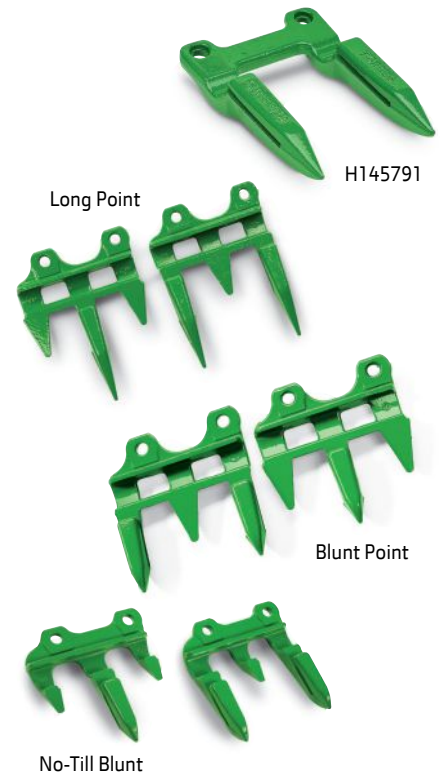

Reel Fingers

Reel Fingers help guide crop into the platform. John Deere reel fingers are made out of a unique high-strength poly that increases the stiffness of the fingers for increased strength.



AH166489



AH166490



AH166491

NUMBER	DESCRIPTION	TYPE	LIST	NOW
900 Series (-645300):				
H127035	Finger (package of 100)	John Deere	\$ 2.34	\$ 2.06
900 Series (645301-685400):				
AH153175	Full Bat (package of 180)	John Deere	\$ 3.41	\$ 3.00
H142315	LH Bat	John Deere	\$ 4.03	\$ 3.71
A-H142315	LH Bat (package of 10)	A&I Products	\$ 3.75	
H142314	RH Bat	John Deere	\$ 4.03	\$ 3.71
A-H142314	RH Bat (package of 10)	A&I Products	\$ 3.75	
900F (685401-), 900R (685401-), 600F, 600R, 600D (-784999), 600FD (-784999) Series				
AH166489	Full Bat (package of 10)	John Deere	\$36.84	\$33.89
AH166490	LH Bat (package of 10)	John Deere	\$50.45	\$46.41
AH166491	RH Bat (package of 10)	John Deere	\$51.96	\$47.80
KXE10477	No Bat (package of 10)	John Deere	\$56.11	\$51.62
HXE28926	Auxiliary Finger	John Deere	\$22.10	\$20.33
600D (785000-), 600FD (785000-), 700D Series				
KXE10423	Finger (package of 10)	John Deere	\$95.78	\$88.12

Auger Fingers Kits

As crop material moves to the center of the platform, auger fingers, finger bearings, and finger guides deliver material to the feeder house. The fingers and bearings should be checked periodically and replaced if there is excessive play. John Deere offers two different types of auger fingers:

Steel Fingers

- John Deere fingers are made out of boron steel and heat-treated for long wear
- A narrow, breakaway groove in the finger protects it and allows the finger to break, rather than bend, to prevent damage to the auger

Composite Fingers

- John Deere composite fingers are known for their strength and resiliency in most crop conditions
- Reduce damage from broken fingers



AH206160



AH214869

NUMBER	DESCRIPTION	TYPE	LIST	NOW
900, 900F, 900R Series:				
AH206160	Steel Finger Kit (set of 8)	John Deere	\$127.65	\$117.44
AH202965	Composite Finger Kit (set of 8)	John Deere	\$148.14	\$136.29
600F, 600R Series:				
AH214868	Steel Finger Kit (set of 10)	John Deere	\$145.22	\$133.60
A-AH214868	Steel Finger Kit (set of 10)	A&I Products	\$112.33	
AH214869	Composite Finger (set of 10)	John Deere	\$ 85.18	\$ 78.37
A-AH214869	Composite Finger (set of 10)	A&I Products	\$ 57.76	

Draper Head Aftermarket Upgrades

Grain Saver Belt

John Deere Grain Saver Belt's special crosshair design helps trap free grain before it can roll past the cutterbar onto the ground, helping you reduce harvest losses and increase revenue. Retrofit kits are available for MY12 600FD and up.



DRAPER WIDTH	SERIES AND MODEL YEAR	LIST
30-foot	630FD: MY12–15*	\$ 9,822.72
30-foot	630FD: MY16–18*	\$ 9,104.30
30-foot	700FD/RDF-Series	\$ 4,724.84
35-foot	635FD: MY12–15*	\$16,557.72
35-foot	635FD: MY16–18*	\$16,237.88
35-foot	700FD/RDF-Series	\$ 8,188.84
40-foot	640FD: MY12–15*	\$17,033.70
40-foot	640FD: MY16–18*	\$16,462.20
40-foot	700FD/RDF-Series	\$ 8,413.16
45-foot	645FD: MY16–18*	\$16,686.52
45-foot	700FD/RDF-Series	\$ 8,637.48

*New Draper Rollers are required for 600FD-Series Retrofit. Contact dealer for full upgrade parts list needed.



Scan for more information

NEW Gauge Wheel Kit

Created for MY21+, HDR/HDF hinged drapers allows a conversion from non-gauge wheels to gauge wheels. Equipping the draper head with this conversion gauge wheel kit will produce consistent stubble height and cut height across the full header. Without leaving the cab, switch from off-ground to on-ground in 10 seconds, saving customers valuable harvest time.

NUMBER	DESCRIPTION	LIST	NOW
KXE10964*	Tire Kit, Non-Gauge Wheel to Gauge	\$7,270.15	\$6,688.54
AXE77160	LH – Tire & Wheel Assembly	\$ 540.34	\$ 497.11
AXE77161	RH – Tire & Wheel Assembly	\$ 540.34	\$ 497.11

*Also order through service parts (2) each LH & RH Tire & Wheel Assembly kits per 1 Conversion Gauge Wheel Kit.



NEW HDR/HDF High Wear Skid Shoes

The HDR/HDF High Wear Skid Shoes double the amount of material in key areas compared to standard for improved wear life. They are recommended for use in highly abrasive and/or rocky conditions.

NUMBER	DESCRIPTION	LIST	NOW
AXE95799	RH Outer Float Arm Skid Plate	\$144.10	\$132.57
AXE95797	LH Outer Float Arm Skid Plate	\$144.97	\$133.37
AXE95777	Wing Skid Plate	\$ 33.85	\$ 31.14
AXE95795	Center Skid Plate	\$ 35.85	\$ 32.98
AXE95796	Wing Pivot Skid Plate	\$ 61.42	\$ 56.51
HXE171356	Skid Plate	\$ 18.42	\$ 16.95



SUPER SAVER

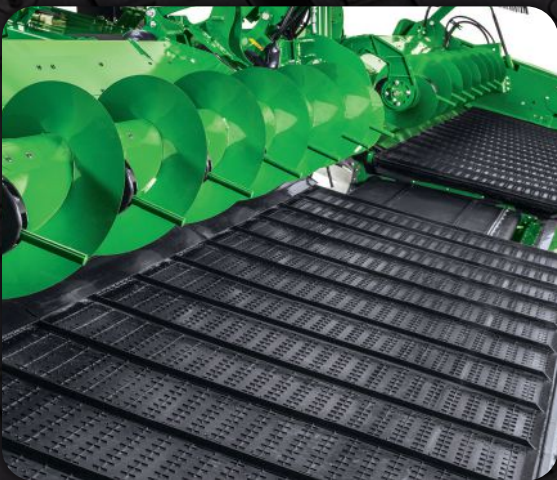

Lose less profit to the land with a **Grain Saver Belt Aftermarket Upgrade** from John Deere. Unlike standard draper belts, grain saver belts feature a *unique crosshair design* that traps free grain and gets it into your tank. As a result, more grain ends up where it belongs to make your operation more profitable.

Grain saver belts are available for John Deere **600FD-Series draper heads and up**. (See page 13 for ordering details.)

Upgrade your combine's performance today.

Walker Combine Parts

Walker Combine Feederhouse Chain

Excessive tension is a major cause of feederhouse conveyor chain wear. It is normal for center strands to sag more because of the weight of the slat and the upward force of crop material.

NUMBER	DESCRIPTION	TYPE	LIST	NOW
Feederhouse Chain (9400, 9410, 9450, 9500, 9510, 9550, 9560):				
AH137604	28 Slat	John Deere	\$1,225.47	\$1,127.43
A-AH137604	28 Slat	A&I Products	\$ 791.97	
AH207777	34 Slat	John Deere	\$1,177.91	\$1,083.68
A-AH207777	34 Slat	A&I Products	\$ 999.03	
AH137845	49 Slat	John Deere	\$1,498.51	\$1,378.63
A-AH137845	49 Slat	A&I Products	\$1,148.09	
Feederhouse Chain (9600, 9610, 9650, 9660):				
AH207778	51 Slat	John Deere	\$1,631.27	\$1,500.77
A-AH143399	51 Slat	A&I Products	\$1,316.90	
AH143400	74 Slat	John Deere	\$1,818.25	\$1,672.79
A-AH143400	74 Slat	A&I Products	\$1,596.33	
Feederhouse Repair Slats (Bolt-On):				
H206436	9400, 9410, 9450, 9500, 9510, 9550, 9560	John Deere	\$ 31.40	\$ 28.89
A-H206436	9400, 9410, 9450, 9500, 9510, 9550, 9560	A&I Products	\$ 20.43	
H207776	9600, 9610, 9650, 9660	John Deere	\$ 23.39	\$ 21.52
A-H207776	9600, 9610, 9650, 966	A&I Products	\$ 10.19	



Rasp Bars

John Deere Black-Hardened Rasp Bars

- Serrated rasp bar has a gently contoured surface design that wears to an even, smooth profile
- Recommended for use in harvesting corn, popcorn, soybeans, malting barley, edible beans, or any seed crop where high quality grain is demanded

John Deere Chrome-Hardened Rasp Bars

- Provide twice the wear life of the non-chromed rasp bars
- Feature a smooth, contoured profile design with sharp surface edges
- Ideal for general use in all crops where long-lasting, efficient threshing performance is desired

NUMBER	DESCRIPTION	TYPE	LIST	NOW
Rasp Bars (9400, 9410, 9450, 9500, 9510, 9550, 9560):				
Black-Hardened				
AH205117	LH	John Deere	\$ 563.61	\$518.52
AH205118	RH	John Deere	\$ 601.91	\$553.76
A-V12068H	Includes LH, RH, and Hardware	A&I Products	\$ 651.81	
Chrome-Hardened				
AH205119	LH	John Deere	\$ 938.40	\$863.33
AH205120	RH	John Deere	\$ 942.49	\$867.09
A-V12068C	Includes LH, RH, and Hardware	A&I Products	\$ 854.22	
Rasp Bars (9600, 9610, 9650, 9660):				
Black-Hardened				
AH205122	LH	John Deere	\$ 697.84	\$642.01
AH205123	RH	John Deere	\$ 745.26	\$685.64
A-V12072H	Includes LH, RH, and Hardware	A&I Products	\$ 783.71	
Chrome-Hardened				
AH205124	LH	John Deere	\$1,036.84	\$953.89
AH205125	RH	John Deere	\$1,052.40	\$968.21
A-V12072C	Includes LH, RH, and Hardware	A&I Products	\$1,024.44	



Black-Hardened



Chrome-Hardened



Clean Grain and Tailings Elevator Chains

Elevator chains should be checked for stretch and adjusted or replaced as required. The rubber paddles can develop rounded corners and edges, resulting in grain leakage. The most common reason for excessive elevator chain wear is too much tension. A chain that has too much tension will get tighter as the chain conveys material and could cause shaft and bearing failures.

NUMBER	DESCRIPTION	TYPE	LIST	NOW
Clean Grain Elevator Chain:				
AH162441	9400, 9410, 9500, 9510	John Deere	\$485.34	\$446.51
A-AH162441	9400, 9410, 9500, 9510	A&I Products	\$337.86	
AH162442	9600, 9610	John Deere	\$499.28	\$459.34
A-AH162442	9600, 9610	A&I Products	\$372.13	
AH162058	9450, 9550, 9560, 9650, 9660	John Deere	\$591.31	\$544.01
A-AH162058	9450, 9550, 9560, 9650, 9660	A&I Products	\$401.29	
Tailings Elevator Chain:				
AH131074	9000, 9010, 9050, 9060	John Deere	\$378.89	\$348.58
A-AH131074	9000, 9010, 9050, 9060	A&I Products	\$309.13	



Vertical Unloading Augers

NUMBER	DESCRIPTION	TYPE	LIST
Regular – Standard auger from the factory on 9000, 9010, 9050 Series:			
AH124852	9400, 9410, 9500, 9510, 9600, 9610	John Deere	\$ 758.49
A-AH124852	9400, 9410, 9500, 9510, 9600, 9610	A&I Products	\$ 655.47
AH171550	9450 (695101-), 9550 (695201-), 9560, 9650 (695301-), 9660	John Deere	\$ 684.82
A-AH171550	9450 (695101-), 9550 (695201-), 9560, 9650 (695301-), 9660	A&I Products	\$ 633.94
Grass – Double-flighted auger provides gentler crop handling:			
AH140081	9400, 9410, 9450 (-695100), 9500, 9510, 9550 (-695200), 9600, 9610, 9650 (-695300)	John Deere	\$ 946.14
High Wear – Constructed with heavy-duty segmented flighting:			
AH154962	9400, 9410, 9500, 9510, 9600, 9610	John Deere	\$1,158.29
A-AH154962	9400, 9410, 9500, 9510, 9600, 9610	A&I Products	\$ 870.72
AH171554	9450 (695101-), 9550 (695201-), 9560, 9650 (695301-), 9660	John Deere	\$1,020.61
A-AH171554	9450 (695101-), 9550 (695201-), 9560, 9650 (695301-), 9660	A&I Products	\$ 857.19



Straw Chopper Knives

Chopper balance must be maintained. Follow operator manual to ensure proper blades are replaced. Depending on type of chopper, either 6- or 8-blades must be replaced to keep balance.

NUMBER	DESCRIPTION	TYPE	LIST
Regular Cut Straw Chopper (one straight blade per support):			
AH124635	9000, 9010, 9050, 9060	John Deere	\$52.17
Fine Cut Straw Chopper (two straight blades per support):			
AH205910	9000, 9010, 9050, 9060	John Deere	\$62.16
A-AH205910	9000, 9010, 9050, 9060	A&I Products	\$53.18
Wide Spread Fine Cut Straw Chopper (two paddle blades per support):			
AH205909	9000, 9010, 9050, 9060	John Deere	\$96.00
A-AH205909	9000, 9010, 9050, 9060	A&I Products	\$71.40

STS and S-Series Combine Parts



Lower Clean Grain Augers

The clean grain auger delivers grain from the shoe to the clean grain elevator. From the clean grain auger, the grain goes to the elevator and up to the grain tank.



NUMBER	DESCRIPTION	APPLICATION	LIST
AXE59539	Clean Grain Lower Auger	9770 and all S-Series	\$1,132.07
AH162154	Clean Grain Lower Auger	All STS and S650, S660, S670, S690, S760, S770	\$ 711.45
AXE45389	Lower Clean Grain Auger	S690, S690H, S790	\$1,491.01

Tailing Augers

The lower tailings auger moves the unthreshed material from the chaffer or sieve to the tailings elevator. The elevator then carries the material to the upper tailings auger which drops the tailings in the center of the separator just above the threshing cylinder.

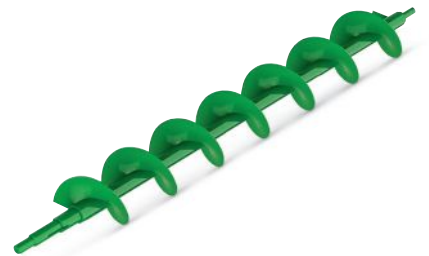

NUMBER	DESCRIPTION	APPLICATION	LIST
AH147472	Lower Tailings Auger	All STS and S560, S650, S660, S670, S690, S760, S770	\$376.08
AH232830	Lower Tailings Auger, Rethresher	S680, S685, S690, S780, S785, S790	\$642.32
AH209421	Upper Tailings Trough Auger	All STS and S560, S650, S660, S670, S690, S760, S770	\$226.03

STS and S-Series Vertical Unloading Augers

There are three different types of vertical augers:

Regular – Standard wear were base equipment on S550, S650, and S660 Combines

High-Wear – Option on S550, S650, and S660 Combines

High-Wear/High Unloading Rate – Standard on S670, S680, and S690 Combines



NUMBER	DESCRIPTION	TYPE	LIST
9650, 9750, 9560, 9660, 9760, 9570, 9670, S560:			
AH146840	Regular	John Deere	\$ 707.06
A-AH146840	Regular	A&I Products	\$ 570.69
AH164070	High-Wear	John Deere	\$ 967.34
A-AH164070	High-Wear	A&I Products	\$ 726.89
9660, 9760, 9860, 9670, 9770, 9870:			
AXE12921	High-Wear/High Unloading Rate	John Deere	\$1,338.61
A-AXE12921	High-Wear/High Unloading Rate	A&I Products	\$ 911.46
S550, S650, S660:			
AXE53848	Regular	John Deere	\$ 656.98
AXE53849	High-Wear	John Deere	\$1,061.31
S660, S670, S680, S690:			
AXE18070	High-Wear/High Unloading Rate	John Deere	\$1,332.80
A-AXE18070	High-Wear/High Unloading Rate	A&I Products	\$ 904.17



Tech Tip:

Keep a clearance gauge handy

John Deere offers a convenient gauge that measures wear on threshing elements, separator tines, and concaves to help you know when it's time to replace them. **Order yours today.**

		LIST	NOW
KXE10110	Variable Stream Rotor Gauge	\$14.76	\$13.58
AH204933	Tri-Stream Rotor Gauge	\$ 4.07	\$ 3.74
MCXFA1962	Chaffer/Sieve Clearance Gauge	\$13.87	\$12.76
KXE10805	X-Series Rotor Gauge	\$10.94	\$10.06

Visit JohnDeere.com/CombineParts to learn more.

STS and S-Series Threshing Elements

It is important to note that three different threshing element designs are needed for the Bullet Rotor:

- First Row of Front Cone: Requires one kit of (3) threshing elements designed for mounting on the front surface of the front cone.
- Second Row of Front Cone: Requires one kit of (3) threshing elements designed for mounting on the surface of the mid-section of the front cone.
- Rear Portion: Requires three kits of (3) threshing elements designed to mount on the rear portion of the rotor.

All threshing elements listed below are available in kits of (3) only. To maintain rotor balance, all three must be installed in a row around the circumference.



NUMBER	DESCRIPTION	TYPE	LIST
Corn and Grain Elements for 9560, 9570, S550:			
AH219770	1st Row	John Deere, Standard-Wear, Rifled	\$1,002.95
AH219771	2nd Row	John Deere, Standard-Wear, Rifled	\$ 607.39
KXE10160	3rd–5th Row	John Deere, Standard-Wear, Rifled	\$ 406.53
AH219773	3rd–5th Row	John Deere, High-Wear, Rifled	\$ 594.38
Corn and Grain Elements for 9660, 9760, 9860, 9670, 9770, 9870, S650, S660, S670, S680, S690:			
AH216674	1st Row	John Deere, Standard-Wear, Rifled	\$ 826.31
A-AH216674	1st Row	A&I Products, High-Wear, Rifled	\$ 582.69
AH216675	2nd Row	John Deere, Standard-Wear, Rifled	\$ 560.82
A-AH216675	2nd Row	A&I Products, High-Wear, Rifled	\$ 424.53
AH216677	3rd–5th Row	John Deere, Standard-Wear, Rifled	\$ 266.31
A-AH216677	3rd–5th Row	A&I Products, Standard-Wear, Rifled	\$ 180.75
AH216678	3rd–5th Row	John Deere, High-Wear, Rifled	\$ 403.56
A-AH216678	3rd–5th Row	A&I Products, High-Wear, Rifled	\$ 274.76

STS and S-Series Separator Tines

All separator tines listed below are available in kits of (3) only. To maintain rotor balance, all three must be installed in a row around the circumference of the rotor.



NUMBER	DESCRIPTION	TYPE	LIST
9560, 9570, S550:			
AH209452	Standard	John Deere	\$220.54
9650, 9750, 9660, 9760, 9860, 9670, 9770, 9870, S650, S660, S670, S680, S690:			
AH208554	Standard	John Deere	\$135.75
A-AH208554	Standard	A&I Products	\$ 82.79
AH209123	High Wear	John Deere	\$252.48
A-AH209123	High Wear	A&I Products	\$184.87

How To Select The Right Concave

With the correct concave configuration, you can enhance combine performance in a wide variety of crops and conditions. Use the concave guidelines below to determine how you can increase the threshing capacity of your **John Deere STS, S-Series, or X-Series combine**. For specialty and seed crops, always use the best-rated concave configuration.

CROP TYPE	CORN	SOYBEANS	SMALL GRAINS (WHEAT, BARLEY)	RICE
SMALL WIRE	NOT RECOMMENDED	NOT RECOMMENDED	BEST ^(4,5)	NOT RECOMMENDED
LARGE WIRE	GOOD ⁽¹⁾	GOOD	GOOD ⁽⁴⁾	BEST
ROUND BAR	BEST	BEST ^(2,6)	AVERAGE ⁽³⁾	NOT RECOMMENDED

CROP TYPE	POPCORN, FOOD CORN	MILO/SORGHUM, SUNFLOWERS (CONFECTION)	SUNFLOWERS (OIL)	CANOLA
SMALL WIRE	NOT RECOMMENDED	NOT RECOMMENDED	NOT RECOMMENDED	BEST ⁴
LARGE WIRE	NOT RECOMMENDED	BEST	BEST	NOT RECOMMENDED
ROUND BAR	BEST	AVERAGE ⁽²⁾	AVERAGE ⁽²⁾	AVERAGE

1. Large-wire concaves are not recommended for corn with moisture above 25 percent. Matting of green, leafy material significantly reduces separating capacity.
2. Optional threshing inserts are available to improve threshing ability in tough threshing varieties or conditions.



Scan for more information

3. Optional concave threshing inserts are required in the first concave to improve threshing ability. Tough threshing conditions may require additional threshing inserts in the second and third concave sections.
4. Optional concave cover plates are available to improve threshing ability and sample cleanliness (white caps, snapped heads, unthreshed pods). Recommended for tough, damp, hard-to-thresh conditions only. Removal of every other wire is recommended for best grain quality results.
5. Optional Kondex® MaxThresh™ Concave in the first section to improve threshing.
6. Optional Kondex® MaxRound™ Concave in the first section to improve threshing.

See following pages for part numbers and pricing.

THRESHING INSERTS

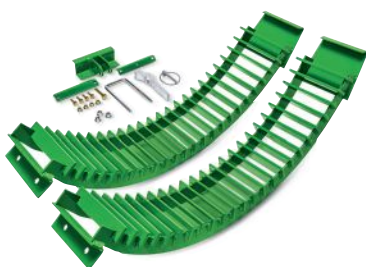

KONDEX® REVOLUTION MAXTHRESH™ CONCAVE FOR STS AND S-SERIES



KONDEX® REVOLUTION™ ROUND BAR CONCAVE FOR X-SERIES





Kondex® Revolution™ MaxRound™
Coarse Grain Bundle Shown
(S-Series/STS)

STS and S-Series Kondex® Revolution™ Half-Width Concaves*

These concaves give more versatility to match varying crop conditions, especially in tough threshing or high moisture crops. Plus they're lighter and easier to change and install.

NUMBER	DESCRIPTION	LIST	NOW
BXE11145	Kondex® Revolution™ Small Grain 2-pc. Bundle	\$2,457.40	
BXE11144	Kondex® Revolution™ Coarse Grain 2-pc. Bundle	\$2,457.40	
AXE91114	Single Kondex® Revolution MaxThresh™ Half-Width Small Slot Concave	\$1,127.02	
AXE76999	Single Kondex® Revolution MaxThresh™ Half-Width Small Slot Concave	\$1,018.78	
AXE77000	Single Kondex® Revolution MaxRound™ Half-Width Concave	\$ 976.31	
AXE76998	Plate, Concave Front Lip	\$ 265.97	\$244.69
BXE11457	Kondex® Revolution™ 6-pc. Half-Width Small Grain Bundle	\$6,173.20	
BXE11458	Kondex® Revolution™ 6-pc. Half-Width Coarse Grain Bundle	\$6,086.30	

*Not available for 9560 STS, 9570, or S550 Combines.



STS and S-Series John Deere Concaves

John Deere OEM Concave's reputation for reliability, optimal threshing and separation is long standing. They also allow for versatility in crops and fine-tuning performance via use of inserts, cover plates or combining with Kondex® Revolution™ concaves.

NUMBER	DESCRIPTION	LIST
BXE10387	Round Bar Extended Wear Concave Kit	\$3,031.60
BXE10388	Small Wire Regular Wear Concave Kit	\$3,789.50
BXE10389	Small Wire Extended Wear Concave Kit	\$4,547.40
BXE10390	Large Wire Regular Wear Concave Kit	\$3,652.00
BXE10391	Large Wire Extended Wear Concave Kit	\$4,390.10

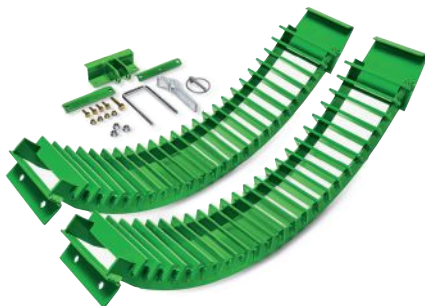

STS and S-Series Concave Inserts

Concave inserts provide the additional threshing action required for harvesting small grains with the round bar concaves. Concave inserts are easy to install and remove as you switch between crops.

NUMBER	DESCRIPTION	TYPE	LIST	NOW
Concave Inserts (9560, 9570, S550):				
BH84294	Set of 2	John Deere	\$ 905.30	\$ 832.88
Concave Inserts (9650, 9750, 9660, 9760, 9860, 9670, 9770, 9870, S650, S660, S670, S680, S690):				
BH84308	Set of 2	John Deere	\$1,277.10	\$1,174.93

STS and S-Series Concave Cover Plates

The sectionalized concave covers help to provide additional threshing in the concave area when harvesting hard-to-thresh-type cereal crops. They can also help to reduce white caps and increase grain tank cleanliness.

NUMBER	DESCRIPTION	LIST	NOW
BH84534	Small Wire and Large Wire Covers	\$770.00	\$708.40
BH84535	Round Bar Covers	\$145.20	\$133.58



Heavy Duty Separator Grates with Interrupters

HD Separator Grates are stiffer and more robust than the standard separator grates for increased performance in tough threshing crops like tough straw and green stemmed beans. HD Weld Separator grate is a welded separator grate while the standard separator grates are single-piece casted steel, and the new HD cast separator grate offers the same robust separator strength, but at a lower price point.

NUMBER	DESCRIPTION	LIST	NOW
AXE44522	HD Weld	\$2,451.77	\$2,255.63
HXE120796	NEW HD Cast*	\$ 505.01	\$ 464.61
HXE120795	NEW HD Cast*	\$ 510.34	\$ 469.51
HXE120794	NEW HD Cast*	\$ 506.35	\$ 465.84

*Must order all 3 part numbers for HD Cast, it comes in 3-pieces.



Separator Grate Covers

Separator grate covers are used to reduce chaff load and alter distribution of material to cleaning shoe. Up to 20 covers may be used. Covers are recommended in small grains but should not be used during corn harvest.

NUMBER	DESCRIPTION	LIST	NOW
BXE10645	Covers (Set of 4)	\$178.20	\$163.94
BXE10646	HD Covers (Set of 20)	\$178.20	\$163.94



STS and S-Series Feederhouse Chain

Excessive tension is a major cause of feederhouse conveyor chain wear. It is normal for center strands to sag more because of the weight of the slat and the upward force of crop material.

NUMBER	DESCRIPTION	TYPE	LIST	NOW
9560, 9570, S550:				
AH231006	Feederhouse Chain	John Deere	\$1,226.55	\$1,128.43
A-AH231006	Feederhouse Chain	A&I Products	\$ 865.32	
9650, 9750, 9660, 9760, 9860, 9670, 9770, 9870:				
AH224926	Feederhouse Chain	John Deere	\$1,337.97	\$1,230.93
A-AH224926	Feederhouse Chain	A&I Products	\$1,016.96	
S650, S660, S670, S680, S690 (Serial Number -775001):				
AXE24307	Feederhouse Chain	John Deere	\$1,774.44	\$1,632.48
A-AXE24307	Feederhouse Chain	A&I Products	\$1,215.93	
S650, S660, S670, S680, S690 (Serial Number 775001-):				
AXE27247	Feederhouse Chain	John Deere	\$2,194.32	\$2,018.77
A-AXE27247	Feederhouse Chain	A&I Products	\$1,561.81	



X-Series Combines



X-Series Threshing Elements



All threshing elements listed below are available in kits of (3) only. To maintain rotor balance, all three must be installed in a row around the circumference of the rotor.

NUMBER	DESCRIPTION	LIST
KXE10755	LH Threshing Element Kit	\$714.94
KXE10756	RH Threshing Element Kit	\$714.94

X-Series Separator Tines



All separator tines listed below are available in kits of (2) only. To maintain rotor balance, both must be installed in a row around the circumference of the rotor.

NUMBER	DESCRIPTION	LIST
KXE10959	Extended Wear Kit	\$148.12

X-Series Kondex® Revolution™ Concaves



Kondex® Revolution™ concaves are made exclusively for John Deere by Kondex and are manufactured using laser cladding high-wear additive, which extends product life by 2–3 times! These concaves give more versatility to match varying crop conditions, especially in tough threshing or high moisture crops.

NUMBER	DESCRIPTION	LIST
BXE11581	Small Grains 4-pc. Bundle	\$5,866.41
BXE11582	Coarse Grains 4-pc. Bundle	\$5,532.49
AXE90830	LH Single Kondex® Revolution MaxThresh™ Half-Width Concave	\$1,449.00
AXE90831	RH Single Kondex® Revolution MaxThresh™ Half-Width Concave	\$1,449.00
AXE90832	Single Kondex® Revolution MaxRound™ Half-Width Concave	\$ 925.34

X-Series John Deere OEM Concaves

John Deere OEM Concave’s reputation for reliability, optimal threshing and separation is long standing. They also allow for versatility in crops and fine-tuning performance via use of inserts, cover plates or combining with Kondex® Revolution™ concaves.

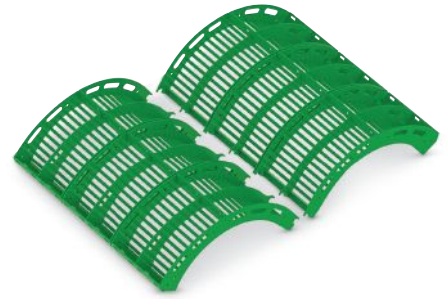

NUMBER	DESCRIPTION	LIST
BXE11375	Round Bar Standard Wear Concave Kit	\$ 4,158.00
BXE11376	Round Bar Extended Wear Concave Kit	\$ 6,323.90
BXE11577	Small Wire Standard Wear Concave Kit	\$ 7,092.23
BXE11578	Small Wire Extended Wear Concave Kit	\$10,839.40
BXE11579	Large Wire Standard Wear Concave Kit	\$ 7,525.34
BXE11580	Large Wire Extended Wear Concave Kit	\$11,357.46

X-Series Concave Inserts

Concave inserts provide the additional threshing action required for harvesting small grains with the round bar concaves. Concave inserts are easy to install and remove as you switch between crops.

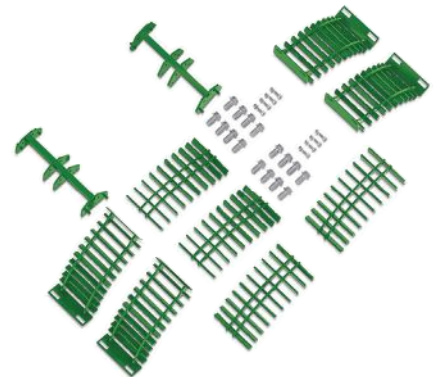

NUMBER	DESCRIPTION	LIST	NOW
AXE90486	Round Bar LH Insert	\$648.98	\$597.06
AXE89573	Round Bar RH Insert	\$573.00	\$527.16

X-Series Concave Cover Plates

The sectionalized concave covers help to provide additional threshing in the concave area when harvesting hard-to-thresh-type cereal crops. They can also help to reduce white caps and increase grain tank cleanliness.

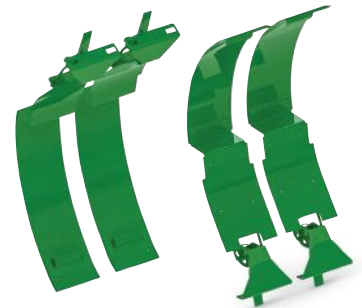

NUMBER	DESCRIPTION	LIST	NOW
BXE11382	Concave Cover Kit	\$652.30	\$600.12

X-Series Elevator Chains

Elevator chains should be checked for stretch and adjusted or replaced as required. The rubber paddles can develop rounded corners and edges, resulting in grain leakage.

NUMBER	DESCRIPTION	LIST	NOW
AXE86232	Clean Grain Elevator Roller Chain	\$1,029.54	\$947.18





X-Series Chopper Knives

X-Series chopper knives deliver value by offering superior residue management, enhanced chopping performance, reduced maintenance requirements, improved harvesting efficiency, and seamless integration with existing equipment.

NUMBER	DESCRIPTION	LIST
KXE10761	Straight Blade	\$213.72

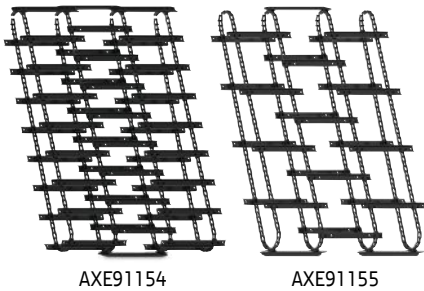

X-Series Feederhouse Chains

The 6-Pitch conveyor chain has 1 slat for every 6th chain link (total 51 slats). This provides better grain quality and is tied to the round bar concave.

The 12-Pitch conveyor chain has 1 slat for every 12th chain link (total 27 slats). This provides better feeding and is tied to small and large wire concaves.

NUMBER	DESCRIPTION	LIST	NOW
AXE91154	Conveyor Chain, 6-Pitch	\$3,667.97	\$3,374.53
AXE91155	Conveyor Chain, 12-Pitch	\$3,037.61	\$2,794.60



X-Series Augers

X-Series augers deliver value by improving harvesting efficiency, preserving grain quality, enhancing productivity, ensuring long-term reliability, and offering seamless integration with existing equipment.

NUMBER	DESCRIPTION	LIST
AXE98517	Lower Clean Grain Auger	\$2,001.72
AXE89023	Loading Auger	\$2,304.06
AXE92496	Vertical Unloading Auger, High-Wear	\$2,144.31



X-Series Separator Grate Covers

Separator grate covers helps balance the shoe load and improves capacity in very dry small grain conditions by reducing the chaff load to the cleaning shoe. Typically one bundle covers 1 grate on each rotor, however, may need 2 covers in extreme dry crop conditions.

NUMBER	DESCRIPTION	LIST	NOW
BXE11383	Separator Grate Cover Kit	\$465.30	\$428.08

Combine AfterMarket Upgrades



Combine Advisor

Combine Advisor utilizes advanced technology and data analytics to provide the operator with real-time recommendations to keep the machine running at its best to maximize productivity and profitability.

NUMBER	DESCRIPTION	LIST	NOW
BXE11609	MY2018–2019, S760 and S770*	\$12,495.46	\$11,495.82
BXE11610	MY2018–2019, S780 and S790*	\$12,495.46	\$11,495.82
BXE11607	MY2020–2021, S760 and S770*	\$14,204.40	\$13,068.05
BXE11608	MY2020–2021, S780 and S790*	\$12,774.09	\$11,752.16
BXE11497	MY2022 S760 and S770 (Combine Advisor Ready)	\$ 9,633.80	\$ 8,863.10
BXE11498	MY2022 S780 and S790 (Combine Advisor Ready)	\$ 9,633.80	\$ 8,863.10
BXE10948	Active Terrain Adjustment Kit Needs to be ordered if Combine not already equipped	\$ 4,878.50	\$ 4,488.22
HXE134118	Combine Advisor Software Must be ordered with each Combine Advisor Bundle		See Us

*Active Terrain Adjustment Kit **BXE10948** needs to be ordered if combine **not** already equipped.

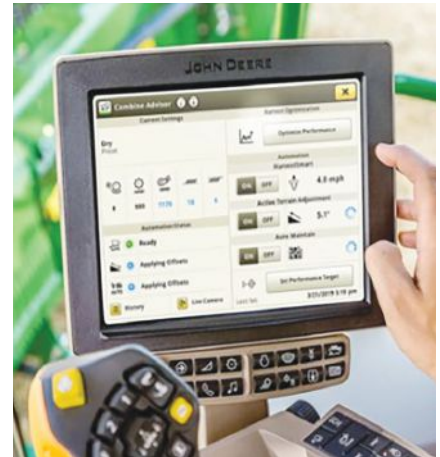

LED Light Kits for S-Series Combines

LED lights provide enhanced visibility and output. Three kits are available to update S600- and S700-Series Combines.

NUMBER	DESCRIPTION	LIST	NOW
BXE11505	Complete Machine LED Light Kit	\$3,912.09	\$3,599.12
BXE11506	Cab Only LED Light Kit	\$1,833.91	\$1,687.20
BXE11507	Machine Work LED Light Kit	\$1,825.03	\$1,679.03





Final Drive Grease Line Kit

Greasing final drives on combines can be difficult to access, especially with dual wheels. This kit includes new grease fittings and hoses to allow greasing the final drives in a more convenient location.

NUMBER	DESCRIPTION	LIST	NOW
BXE11469	Grease Line Kit	\$306.90	\$282.35



Headrests

Aftermarket headrests are available in **cloth** and **leather** options, and both can tilt forward and rearward. Compatible in 50, 60, 70, S600, S700 Combines as well as SPFH's and Sugar Harvesters.

NUMBER	DESCRIPTION	LIST	NOW
AXE96856	Leather Headrest (S700-Series)	\$441.12	\$405.83
AXE96857	Cloth Headrest (S700-Series)	\$399.69	\$367.71
AL210444	Guide Kit, Backrest Extension*	\$ 49.99	\$ 45.99

*AL210444 is only needed with a leather seat.



In-Cab Tablet Mounts

Enjoy hands-free access and improved viewing of your tablet from the seat of your cab. These mounting brackets are adjustable, providing easy access without interfering with visibility or machine controls.

NUMBER	DESCRIPTION	LIST	NOW
BXE10479	Tablet Mount (MY12–17 S600-Series)	\$145.20	\$133.58
BXE10901	9–10 in. Tablet Mount (S700-Series)	\$232.10	\$213.53
BXE10864	11–12 in. Tablet Mount (S700-Series)	\$247.50	\$227.70



Heated Floor Mat

The heated floor mat is the same material and color as the existing floor mat and lays over the top of it. The heated floor mat plugs into an auxiliary power strip. It conducts heat directly under the operator's feet from an internal heating element.

NUMBER	DESCRIPTION	LIST	NOW
BXE11223	Heated Floor Mat (S500-, S600-, S700-Series)	\$650.10	\$598.09

RUN WISER WITH COMBINE ADVISOR™



Take the guesswork out of important harvest operations with Combine Advisor. This aftermarket upgrade for S700 through X-Series Combines features three advanced automation technologies to help you improve grain quality and operational efficiencies. The robust suite includes:

HarvestSmart™	Active Terrain Adjustment™	AutoMaintain w/ActiveVision™
Senses varying crop conditions and automatically adjusts combine ground speed to maintain a consistent load in the rotor.	Enhances grain quality and minimizes grain loss on hills; stabilizes tailings levels; and ensures clean tank samples.	Maintains grain loss/grain quality performance targets as conditions change to eliminate manual adjustments.

Contact us to learn more.



Precision Ag Modems – R Modem

- The 4G modem is ideally suited for advanced telematics applications such as machine health monitoring, advanced logistics, machine control, and remote diagnostics. It is environmentally sealed and rigorously tested to ensure performance in the most demanding environmental conditions.
- The JDLink™ R Modem - 4G is the recommended 2G or 3G upgrade solution for most situations.

The 4G modem with a high-profile antenna (PFA10882) is required for the following:

- Machine Sync
- Machines requiring wireless or Bluetooth® wireless functionality
- New machine installations

Benefits

- When upgrading existing 2G/3G with JDLink™ R Modem - 4G: Quickly and easily upgrade older machines with the latest hardware solutions
- Keep costs low as kit uses existing parts for mounting previous generation antennas

NUMBER	DESCRIPTION
--------	-------------

PFA12692	R Modem
----------	---------

[See us for pricing.](#)



Precision Ag Modems – M Modem

- The JDLink™ M modem is a perfect complement to new G5 and G5^{Plus} Universal displays – particularly in older John Deere or non-John Deere machines and is also compatible with older generations of John Deere displays.
- The M modem gives you one portal for seamless data flow, automated data transfer and remote dealer support. That connection with your dealer provides machine monitoring, fleet management, machine maintenance plans and important machine alerts. With all your machines (Deere and non-Deere alike) connected in this one way, you get a consistent, reliable view of your data, your equipment, and the activities of your operation.

The M modem is an option for you if:

- You run older machines that didn't come with built-in modem
- You own a mixed fleet and want all data to go into Operations Center
- You rent smaller tractors that didn't come with built-in modem

NUMBER	DESCRIPTION
--------	-------------

PFA12802	M Modem
----------	---------

[See us for pricing.](#)

Precision Ag Solutions for Harvest

Combine – AMS Display & Receiver Brackets

Get ready for harvest with the right attachments for your combine displays and receivers.

NUMBER	DESCRIPTION	LIST
AH211594	GreenStar™ Display Bracket, 60- or 70-Series Combines	\$196.42
BPF11186	Cornerpost Display Bracket Kit, S-Series Combines	\$218.90
BPF11356	Universal GPS Bracket	\$237.60
PF10758	StarFire™ Receiver Deluxe Shroud Conversion Bracket	\$ 99.89
PF90500	Combine StarFire™ Position Receiver Bracket – 60-Series	\$302.50
PF91009	Combine StarFire™ Position Receiver Bracket – 50-Series	\$121.00



Combine Mass Flow and Moisture Sensors

Mass-flow sensors are mounted in the grain tank on the top of the clean-grain elevator head assembly. The sensor is used for accurate yield measuring.

NUMBER	DESCRIPTION	LIST
PF90866	Sensor Kit, Mass Flow and Moisture – 9400, 9500, or CTS	\$2,783.00
PF90867	Sensor Kit, Mass Flow and Moisture – 9400, 9500, or CTS	\$2,783.00
PF90864	Sensor Kit, Mass Flow and Moisture – 9600 Models	\$2,783.00
PF90865	Sensor Kit, Mass Flow and Moisture – 9600 Models	\$2,783.00
PF90868	Sensor Kit, Mass Flow and Moisture – 9610 Models	\$2,783.00
PF90869	Sensor Kit, Mass Flow and Moisture – 9610 Models	\$2,245.10

For parts with core charge, price shown is the exchange price after core is returned.

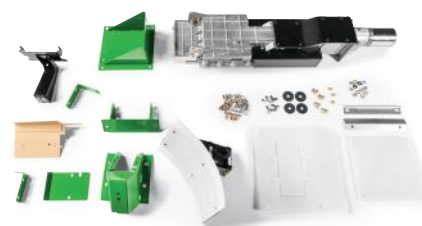

Guidance & Machine Control

AutoTrac™ Integrated Machine Kits and GreenStar™ Ready Kits make it easy for you to be Precision Ag-ready when the time arrives. The AutoTrac Machine Kits include the appropriate machine steering controller when necessary and AutoTrac Ready accessories. The display, receiver, and software to complete the system are sold separately. These field-installed kits are an integrated guidance solution for John Deere machines and are compatible with the GreenStar 3 or GreenStar 2 system components. Gain the edge and get the results you want and need with genuine John Deere AMS components.

NUMBER	DESCRIPTION	APPLICATION	LIST
PF90876	AutoTrac™ Combine Machine Kit	50-Series	\$6,473.50
PF90875	AutoTrac™ Combine Machine Kit	60-Series	\$5,566.00
PF90629	AutoTrac™ Combine Machine Kit	70-Series	\$5,566.00
PF90863	AutoTrac™ Tractor Machine Kit	8000-Series	\$5,142.50
PF90862	AutoTrac™ Tractor Machine Kit	8010-Series	\$4,840.00
PF90497	AutoTrac™ Tractor Machine Kit	8020-Series	\$4,840.00
BPF12231	GreenStar™ Ready Universal Guidance Kit, Upgradable	John Deere and other makes equipment	\$ 907.50
BPF12305	AutoTrac™ RowSense™ Kit for Universal Sensor	Combines	\$ 947.10
PF91001	AutoTrac™ RowSense™ Universal Sensor	Corn Heads	\$1,023.00
PF90697	AutoTrac™ RowSense™ Mechanical Feelers	30-in. or 75cm Spacing	\$1,023.00
PF90755	AutoTrac™ RowSense™ Retrofit Kit	50- or 60-Series John Deere Combines	\$ 423.50
PF90757	AutoTrac™ RowSense™ Retrofit Kit	90-Series Corn Heads	\$ 665.50

For parts with core charge, price shown is the exchange price after core is returned.



PF90697



Maintenance made easy.

Filter Paks for Compact Utility Tractors

Keep your tractor running at its peak. Most kits contain an oil filter, air filter, fuel filter, and hydraulic filter.



Scan this code to view our Compact Tractor DIY Maintenance videos

NUMBER	APPLICATION	LIST
LVA21035	Filter Pak, 1023E (SN -117913) and 1026R Tractors	\$ 75.31
LVA21036	Filter Pak, 1025R (SN -153036), 2025R (SN HH100001-HH103920), w/ Engine Mount Air Filter	\$ 75.04
LVA21196	Filter Pak, 2210 Tractors	\$ 79.57
LVA21200	Filter Pak, 2305 Tractors	\$ 79.32
LVA21204	Filter Pak, 2320 and 2025R (SN -HH100000) Tractors	\$122.55
LVA21201	Filter Pak, 2520, 2720, and 2032R (SN GH100008-) Tractors	\$ 55.11
LVA21128	Filter Pak, 3032E and 3038E (SN -610,000) Tractors	\$101.03
TA26997	Filter Pak, 3032E and 3038E (SN 610,000-) Tractors Filter Pak, 3025E	\$155.91
TA25769	1023E* (SN 117914-), 1025R* (SN 153037-), 2025R* (SN 103921-), or Updated Models with Fan Shroud Mount Air Filters	\$ 75.36
TA25767	Filter Pak, 2032R (SN -GH100007) and 2038R Tractors	\$151.40
TA25768	Filter Pak, 3033R, 3039R, and 3046R Tractors	\$236.28
TA25765	Filter Pak, 4M and 4R Series Tractors	\$213.73
LVA21202	Filter Pak, 3120, 3320, 3520, 3720, 4005, and 4105 Tractors	\$144.73
LVA21192	Filter Pak, 4010 Tractors	\$ 66.73
LVA21197	Filter Pak, 4100 and 4110 Tractors	\$ 53.51
LVA21193	Filter Pak, 4115 Tractors	\$ 51.69
LVA21203	Filter Pak, 4120, 4320, 4520, and 4720 Tractors	\$146.51
LVA21198	Filter Pak, 4200, 4300, and 4400 Tractors	\$ 92.67
LVA21194	Filter Pak, 4210, 4310, and 4410 Tractors	\$155.48
LVA21199	Filter Pak, 4500, 4600, and 4700 Tractors	\$ 93.15
LVA21195	Filter Pak, 4510, 4610, and 4710 Tractors	\$155.96

* Fits Hydrostatic Transmissions only, not for PowrReverser™ Transmissions.

JUST STOW AND GO



JOHN DEERE TOOL STORAGE

Have the right tools for the job at hand with **John Deere Tool Storage**. Now you can safely transport lots of landscaping and power equipment and reduce trips to the garage or shed. Featuring modular design for various tractor mounting configurations, load up items like:

- Shovels
- Trimmers
- Chain Saws
- Rakes
- Blowers

Tool Storage simply attaches to a ROPS, ballast box, or iMatch™ Quick-Hitch. And it doesn't interfere with tractor functionality. Wall mounting accessories are also available for storage.

Available in store or order online at Shop.Deere.com.

NUMBER	DESCRIPTION	LIST
5WS812425	ROPS Rack	\$227.73
5WS812430	ROPS Rack (3D, 3E, 4M, 4R)	\$248.13
5WS812435	Universal Mount Kit	\$ 22.66
5WS812450	Long Tool Holder (Double)	\$ 81.58
5WS812455	Long Tool Holder (Quad)	\$107.64
5WS812460	Chainsaw Holder	\$ 95.17
5WS812466	Handheld Leaf Blower Holder	\$163.15
5WS812470	Chain Box	\$129.16
5WS812475	String Trimmer Holder	\$ 66.85
5WS812480	Mini Clamp Kit	\$ 38.52
5WS812485	Clamp Kit	\$ 44.19
5WS812490	Super Clamp Kit	\$ 57.78

BUY NOW



Canopies for Compact and Utility Tractors

Protect yourself from extreme weather conditions throughout the year with a canopy from John Deere.



BXX10589 Canopy with BXX10591 Fan Kit



A-C7481G Universal Fit Metal Canopy

NUMBER	APPLICATION	LIST
Canopy:		
BXX10589	Small ShadePro™ Canopy Fits 1023E, 1025R, and 2025R Model Year 2017 (SN HH1000001-) and Newer Tractors	\$ 813.37
BXX10591	ShadePro™ Fan Kit For Use With ShadePro™ Canopy BXX10589	\$ 595.94
BXX10590	Large ShadePro™ Canopy Fits 2032R, 2038R, 3E, 3R, 4M, 4MHD, and 4R Model Year 2017 and Newer Tractors	\$ 763.40
LVB25334	Standard Canopy Fits 3E, 3R, 4M, 4R, 5D, 5E, 5M, 3320, 3520, 3720, 4105, 4320, 4520, 4720, 5003, 5020, and 5025	\$ 750.61
AR201256	Fits 6000, 6010, 6030, 6015, 6003, 6005, 7020, and 7030 Series Open Station	\$1,895.30
RE270484	Deluxe Canopy fits 5D, 5E, 5M, 5003, 5025, 5105, 5205, and 5020 Series Tractors	\$1,299.11
Metal Canopy:		
A-C2887G	42" x 52" for John Deere Compact Utility Tractors. Fits 1023E, 1025R, 1026R, 2025R, 2026R, 2032R, and 2038R	\$ 433.81
A-C7481G	47" x 58" Universal Fit Green Metal Canopy Kit (Hardware Included) – 18 degrees of angle fore or aft, powder-coated finish, and insulated to reduce noise/vibrations/heat transfer	\$ 535.71

Additional Mounting Hardware might be required. Ask us about the proper mounting hardware for your machine.
 *Each kit includes all necessary universal mounting brackets and hardware to accommodate Roll Over Protection Systems (ROPS) that are between 27"-40" wide. Also available in Red, Blue, or Orange. Ask us for details.

NEW Frontier Trailer Mover

Introducing the new Frontier Trailer Mover, the latest product from Frontier. Now you can easily move bumper pull or gooseneck trailers up to 3,000-lbs.



NUMBER	DESCRIPTION	LIST
5TITE511329	Frontier Trailer Mover	\$390.82

Category 2 Quick-Hitch

Benefits Include:

- Cast design for strength and durability
- Does not interfere with rear fenders
- Lighter weight than the existing Category 2 quick hitch weighing in at 138.9-lb. in comparison to 187.4-lb. for TY27545



NUMBER	LIST
BSJ10595	\$1,033.46

This is easy.



SEE IT IN ACTION

John Deere Quik-Knect™ System

The easy way to connect rotary cutters, tillers, and other PTO-driven implements.



SEE IT IN ACTION

Load-N-Go™ Attachment

The easy way to move your AutoConnect™ mid-mount mower deck.



JOHN DEERE

Make it easy on yourself. Talk to us to find out more.

AutoConnect™, Load-N-Go™, and Quik Knect™ are trademarks owned by Deere & Company.
John Deere, the leaping deer symbol, and green and yellow trade dress are trademarks of Deere & Company.

Maintain Your 7R-Series Tractor



Cab Upgrades

John Deere has a wide selection of tractor cab repair parts to upgrade or repair your John Deere tractor cab. You can either kick up your feet and drive it like a boss with our easy to install foot rests or upgrade your seat for better support in the harshest terrain where ride comfort adjustment still can be dialed in by the individual operator. With such comfort, you can also reduce the heat of the hot sun with a new visor or sun shade so you can see your screen better while using our wireless phone mount providing a safe and convenient way to mount your mobile device.

NUMBER	DESCRIPTION	LIST	NOW
BRE10458	Footrest Kit	\$ 112.20	\$ 103.22
TA35930	Mounting Parts, LED Beacon Light	\$ 112.21	\$ 103.23
RE596959	3-pin Convenience Outlet	\$ 34.39	\$ 31.64
RE596958	6-outlet Powerstrip	\$ 58.88	\$ 54.17
BRE10575	Mounting Rail, C-post (8R and 9R Series Tractors)	\$ 102.30	\$ 94.12
BRE10588	Category 4 Cab Air Filtration System Kit	\$1,883.20	\$ 1,732.54
BXX11490	Field Installed Foot Throttle Kit	\$ 205.70	\$ 189.24
BRE10511	Adjustable Footrest Kit	\$ 128.70	\$ 118.40
RE593670	Rear Sun shade	\$ 150.43	\$ 138.40
RE584990	Leather Steering Wheel	\$ 268.70	\$ 247.20
RE593672	Cab Refrigerator	\$1,660.10	\$ 1,527.29
RE588734	Rear View Mirror	\$ 30.85	\$ 28.38
BRE10452	120-V AC Power Inverter	\$ 213.40	\$ 196.33
BRE10453	230-V AC Power Inverter	\$ 359.75	\$ 330.97

NUMBER	DESCRIPTION	LIST	NOW
RE597710	Wiring Harness, Business Band Radio	\$ 18.70	\$ 17.20
RE37651	Plug, Monitor w/Leads	\$ 45.83	\$ 42.16
RE67015	3-way Convenience Adapter For Power Strip	\$ 39.05	\$ 35.93
RE588540	External StarFire™ Mounting Bracket	\$ 31.89	\$ 29.34
R569171	Custom Door Lock Handle Kit With 2 Keys	\$111.10	\$ 102.21
BRE10451	Subwoofer & Tweeter	\$488.40	\$ 449.33
BXX11045	Remote-mounted Display For Touchscreen Radio	\$385.00	\$ 354.20
BRE10502	Auxiliary Camera Input Kit	\$213.40	\$ 196.33
BRE10152	Self Leveling Cup Holder	\$ 85.80	\$ 78.94
BXX10988	Quick-Grip Phone Mount	\$211.20	\$ 194.30
BXX10987	X-Grip Phone Mount	\$195.80	\$ 180.14
BXX10883	Cup Holder Kit	\$ 33.69	\$ 30.99
BRE10202	Floor Insulation Kit	\$138.60	\$ 127.51



Hydraulics

NUMBER	DESCRIPTION	LIST	NOW
BRE10212	Hydraulic Oil Cooler Screen	\$ 770.00	\$ 708.40
BRE10067	Six Mid SCV Quick Coupler	\$ 642.40	\$ 591.01
BRE10068	Four Mid SCV Quick Coupler	\$ 441.10	\$ 405.81
RE340789	Third Mid-mounted SCV	\$1,245.20	\$ 1,145.58
RE340785	First and second Mid-Stack SCV with TLS	\$2,806.10	\$ 2,581.61
RE340786	First and second Mid-Stack SCV without TLS	\$2,718.10	\$ 2,500.65
RE340780	Second Mid-Stack SCV	\$ 546.70	\$ 502.96

NUMBER	DESCRIPTION	LIST	NOW
RE340782	Third Mid-Stack SCV	\$ 261.80	\$ 240.86
BRE10048	Fifth Rear SCV	\$3,466.10	\$ 3,188.81
BRE10049	Sixth Remote SCV with Electrohydraulic Controls	\$3,466.10	\$ 3,188.81
BRE10075	Hydraulic Quick-connect Power Beyond Coupler (0.5 in.)	\$1,244.10	\$ 1,144.57
RE300467	Power Beyond Couplers	\$ 575.30	\$ 529.28
RE328941	Hitch Auxiliary Raise Kit	\$ 140.80	\$ 129.54



Maintain Your 8R-Series Tractor



Rubber Tracks Belts

Rubber Track Belts are worn-out when the tread bar is 1/2" or less in height, cables are protruding from the carcass, or drive lug wear exceeds 50%. A selection of track belt options are available for your tractor. The track belt list below is only a small sample of track belt selections available for two and four track tractors.

NUMBER	DESCRIPTION	LIST	NOW	NUMBER	DESCRIPTION	LIST	NOW
TR129235	Trackman by Loc® Track Belt, 18 inch Wide	\$10,868.00	\$ 9,998.56	R545861	Camso Track Belt 25-in., 4500 Series	\$10,810.00	\$ 9,945.20
TR130817	Trackman by Loc® Track Belt, 16 inch Wide	\$10,824.00	\$ 9,958.08	R545864	Camso Track Belt 30-in., 6500 Series	\$14,664.00	\$13,490.88
R545855	Camso Track Belt, 16-in., RH, 6500 Series	\$11,515.00	\$10,593.80	R545863	Camso Track Belt 30-in., 4500 Series	\$12,220.00	\$11,242.40
R545854	Camso Track Belt, 16-in., LH, 6500 Series	\$11,515.00	\$10,593.80	R545872	Camso Track Belt, 30-in., 4500, Side Hill	\$15,960.00	\$14,683.20
R545859	Camso Track Belt, 18-in., 6500 Series	\$11,280.00	\$10,377.60	R563760	Camso Track Belt, 16-in., 6500	\$11,054.00	\$10,169.68
R545856	Camso Track Belt 18-in., 4500 Series	\$ 9,400.00	\$ 8,648.00	R545865	Camso Track Belt, 25-in., Side Hill	\$11,351.00	\$10,442.92
R545860	Camso Track Belt 24-in., 4500 Series	\$10,622.00	\$ 9,772.24	R545866	Camso Track Belt, 30-in., Side Hill	\$12,831.00	\$11,804.52
R545862	Camso Track Belt 25-in., 6500 Series	\$12,972.00	\$11,934.24	R545938	Camso Track Belt, Side Hill, 30-in.	\$13,440.00	\$12,364.80
				R545939	Camso Track Belt, Side Hill, 25-in.	\$10,500.00	\$ 9,660.00

All applicable rubber track belts are not listed above. Please contact your local John Deere dealer to discuss our complete track belt portfolio offering.

Independent Suspension Link

John Deere released the Independent Link Suspension System (ILS) with model year 2002. Since then, we have made improvements to several components. Tractor owners with ILS tractors may encounter symptoms and conditions that normally happen as parts wear out and our update solutions will restore ILS performance. If it's time to replace the steering and suspension parts on your ILS front end, see your local John Deere dealer.



NUMBER	DESCRIPTION	LIST	LIST	NUMBER	DESCRIPTION	LIST
RE587967	Inner Tie-Rod End	\$ 974.93	\$ 896.94	A-RE216822	Outer Tie-Rod	\$355.99
RE583653	Outer Tie Rod	\$ 694.04	\$ 638.52	A-RE567107	Seal Kit, ILS Steering Cylinder (Repl. RE556361, RE304943) (NEW)	\$121.40
RE587968	Tie-rod Assembly (Inner and Outer)	\$1,670.34	\$1,536.71	A-RE580643	Ball Joint	\$446.25
RE580643	Upper/Lower Control Arm Ball Joint	\$ 667.01	\$ 613.65	A-RE583653	Tie Rod End (Repl. RE184942, RE216822)	\$349.01
RE584459	A-Arm Upper Pivot Shaft Expander Pin	\$1,289.53	\$1,186.37			

Vari-cool™ Fan Drives

The updated driver and driven assemblies will improve serviceability and reliability of the fan drive assembly. The new dry driver and dry driven assemblies require no grease. The customer will no longer need to lubricate these two components once the update is complete. To maximize the reliability of the fan drive system, we encourage customers to replace the driver and driven assemblies at the same time. A worn driven assembly will potentially reduce the expected life of a new driver when only the driver is replaced.

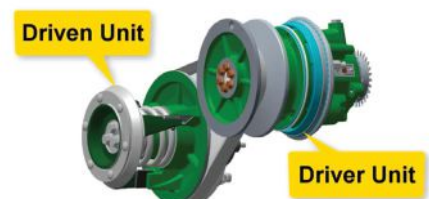

NUMBER	DESCRIPTION	LIST	NUMBER	DESCRIPTION	LIST
RE578435	Fan Drive, Dry Driver Assembly 9L,	\$1,504.66	RE572544	Fan Drive, Dry Driven Assembly 9L,	\$859.43
RE572545	Fan Drive, Dry Driven Assembly 9L,	\$ 900.14	RE582570	Fan Drive, Dry Driven Assembly 9L,	\$894.39
RE587430	Fan Drive, Dry Driver Assembly 9L,	\$1,464.94	R568198	V-Belt	\$ 80.85

Maintain Your 9 Family Tractor



Rubber Track Belts*

Your farming operation is unique, and our robust line-up of rubber track belt offerings is designed to meet the needs of your specific application. Your local John Deere Dealer Technicians are equipped with the resources, experience and expertise to provide unmatched undercarriage service and support. Visit your local dealer for track belt selection, installation and alignment today!

NUMBER	DESCRIPTION	LIST	NOW	NUMBER	DESCRIPTION	LIST	NOW
R257977	Camso Track Belt, 30-in., 3500 Series	\$14,000.00	\$12,880.00	R550588	Camso Track Belt, 30-in., 3500 Series	\$10,200.00	\$ 9,384.00
R257978	Camso Track Belt, 36-in., 3500 Series	\$16,100.00	\$14,812.00	R550228	Camso Track Belt, 36-in., 3500 Series	\$13,260.00	\$12,199.20
R241748	Camso Track Belt, 30-in., 5500 Series	\$16,800.00	\$15,456.00	R554229	Camso Track Belt, 30-in., 6500 Series	\$12,240.00	\$11,260.80
R241749	Camso Track Belt, 36-in., 5500 Series	\$19,320.00	\$17,774.40	R554230	Camso Track Belt, 36-in., 6500 Series	\$15,912.00	\$14,639.04
R545869	Camso Track Belt, 30-in., Scraper, 6500 Series	\$19,456.00	\$17,899.52	R550589	Camso Track Belt, Scraper, 30-in., 6500 Series	\$13,056.00	\$12,011.52
R545868	Camso Track Belt, 30-in., 6500 Series	\$18,240.00	\$16,780.80	R565017	Camso Track Belt, Scraper, 18-in., 6500 Series	\$10,200.00	\$ 9,384.00
R545867	Camso Track Belt, 30-in., 4500 Series	\$15,200.00	\$13,984.00	R565018	Camso Track Belt, Scraper, 24-in., 6500 Series	\$12,240.00	\$11,260.80
R545871	Camso Track Belt, 36-in., 6500 Series	\$20,976.00	\$19,297.92				
R545870	Camso Track Belt, 36-in., 4500 Series	\$17,480.00	\$16,081.60				

All applicable rubber track belts are not listed above. Please contact your local John Deere dealer to discuss our complete track belt portfolio offering.

Attachments For Your Convenience*

Keep your tractor running while efficiently maximizing your yield in the field. Ask your local John Deere dealer for applicable attachments for your machine.

NUMBER	DESCRIPTION	LIST	NOW	NUMBER	DESCRIPTION	LIST	NOW
BXX10302	Auxiliary Light Kit	\$ 150.70	\$ 138.64	RE267658	3 m (9.8-ft.) Front Wheel Spacer (425 mm [16.7-in.] Bolt Circle Hub)	\$4,917.00	\$4,523.64
BXX10154	Axle Kit For Conv. to 2032mm (80-in.)	\$ 3,318.70	\$ 3,053.20	BRE10130	3 m (9.8-ft.) Front Wheel Spacer (500 mm [19.7-in.] Bolt Circle Hub)	\$4,917.00	\$4,523.64
BXX10155	Axle Kit For Conv. to 2235mm (88-in.)	\$ 7,716.50	\$ 7,099.18	BRE10132	Front Wheel Dual Extensions (425 mm [16.7-in.] Bolt Circle Hub)	\$4,074.40	\$3,748.45
BXX10156	Axle Kit For Conv. to 3048mm (120-in.)	\$14,661.90	\$13,488.95	BRE10548	Front Wheel Dual Extensions (500 mm [19.7-in.] With ILS Bolt Circle Hub)	\$4,767.40	\$4,386.01
BXX10157	Axle Kit For Conv. to 2210mm (87-in.)	\$ 3,207.60	\$ 2,950.99	BRE10168	Fifth Or Sixth SCV (Stand. Flow Valve)	\$ 997.70	\$ 917.88
BXX10158	Axle Kit For Conv. to 3048mm (120-in.)	\$26,191.00	\$24,095.72	RE303735	Fifth Remote SCV Kit	\$1,705.00	\$1,568.60
BXX10720	Inner Drive Sprocket Mud Scrapers	\$ 2,250.60	\$ 2,070.55	RE310796	Sixth Remote SCV	\$3,316.50	\$3,051.18
BRE10249	Idler Debris Shield Kit	\$ 698.50	\$ 642.62	BRE10111	Pwr Beyond Coup. Kit (1.9cm,0.75-in.)	\$ 788.70	\$ 725.60
BRE10307	Rear Idler Debris Shield	\$ 630.30	\$ 579.88	BRE10203	Hitch Auxiliary Raise Kit (For Double-Reduction Axles)	\$ 290.40	\$ 267.17
BRE10348	Inner Drive Sprocket Mud Scrapers	\$ 454.30	\$ 417.96				
BRE10393	Sidehill Idler Spacer Kit	\$ 907.50	\$ 834.90				
RES92596	Track Tension Hose Kit	\$ 559.35	\$ 514.60				

*Contact your local John Deere Dealer for specific part requirements and further details.

Maintain Your 7, 8, 9 (10-Series) Tractor



Rubber Track Belts for 8010 and 9010 Series*

NUMBER	DESCRIPTION	LIST	NOW
R241743	Camso Track Belt, 18-in., 3500 Series	\$ 8,000.00	\$ 7,360.00
R220829	Camso Track Belt, 25-in., High Traction, 3500 Series	\$10,500.00	\$ 9,660.00
R292528	Camso Track Belt, 30-in., 3500 Series	\$12,800.00	\$11,776.00
R222976	Camso Track Belt, 18-in., 5500 Series	\$ 9,600.00	\$ 8,832.00
R312148	Camso Track Belt, 18-in., Diagonal TB (LH)	\$10,000.00	\$ 9,200.00
R312149	Camso Track Belt, 18-in., Diagonal TB (RH)	\$10,000.00	\$ 9,200.00
R241750	Camso Track Belt, 25-in., 5500 Series	\$12,000.00	\$11,040.00
R241742	Camso Track Belt, 16.5-in., 3500 Series	\$ 7,840.00	\$ 7,212.80

NUMBER	DESCRIPTION	LIST	NOW
R222974	Camso Track Belt, 16.5-in., Diagonal TB (RH) 5500 Series	\$ 9,408.00	\$ 8,655.36
R222975	Camso Track Belt, 16.5-in., Diagonal TB (LH) 5500 Series	\$ 9,408.00	\$ 8,655.36
R292531	Camso Track Belt, 30-in., 5500 Series	\$15,360.00	\$14,131.20
R545855	Camso Track Belt, 16.5-in., Diagonal TB (RH) 6500 Series	\$11,515.00	\$10,593.80
R545854	Camso Track Belt, 16.5-in., Diagonal TB (LH) 6500 Series	\$11,515.00	\$10,593.80
R545859	Camso Track Belt, 18-in., 6500 Series	\$11,280.00	\$10,377.60
R545856	Camso Track Belt, 18-in., 4500 Series	\$ 9,400.00	\$ 8,648.00
R545861	Camso Track Belt, 25-in., 4500 Series	\$10,810.00	\$ 9,945.20

All applicable rubber track belts are not listed above. Please contact your local John Deere dealer to discuss our complete track belt portfolio offering.

Cab Upgrades*

NUMBER	DESCRIPTION	LIST	NOW
RE343982	Throttle Kit, Speed Control Pedal	\$500.50	\$460.46
RE150012	Throttle Kit, Speed Control Pedal	\$184.80	\$170.02
RE67015	3-way Convenience Adapter for Power Strip	\$ 39.05	\$ 35.93
RE55262	Rearview Mirrors	\$698.50	\$642.62
BXX10987	X-Grip Phone Mount	\$195.80	\$180.14
BXX10988	Quick-Grip Phone Mount	\$211.20	\$194.30

NUMBER	DESCRIPTION	LIST	NOW
RE192707	Instructional Seat (Bundle for 800 Series Wheel and Track Tractors)	\$ 480.01	\$441.61
RE195932	Instructional Seat (All 9000 Series Wheel Tractors)	\$1,038.46	\$955.38
AR112601	Front And Rear Windshield Washer	\$ 259.60	\$238.83
RE337751	Rear Windshield Wiper Kit	\$ 327.80	\$301.58

Hydraulic Pumps, Parts, Quick Couplers*

NUMBER	DESCRIPTION	LIST	NOW
A-AL221083	Hyd. Quick Coupler Socket	\$ 82.44	
RE50393	Control Kit, Power Beyond Coupler	\$ 568.70	\$ 523.20
RE39738	Power Beyond Coupler Kit	\$ 551.10	\$ 507.01
RE217697	Power Beyond and Coupler Kit	\$ 733.70	\$ 675.00
RE174947	3rd SCV With Deluxe Couplers	\$1,491.60	\$1,372.27
RE39731	3rd SCV With Deluxe Couplers	\$1,491.60	\$1,372.27
RE175296	3rd SCV With Deluxe Couplers	\$1,491.60	\$1,372.27

NUMBER	DESCRIPTION	LIST	NOW
AR114664	Hydraulic Motor Return, Multiple Auxiliary Hitch Coupler/Sump Return Kit	\$ 324.50	\$ 298.54
RE151894	Hydraulic Quick-Connect Coupler	\$ 240.90	\$ 221.63
RE67182	Multiple Motor Return Kit	\$ 360.80	\$ 331.94
AR152164	Selective Control Valve Kit	\$2,740.10	\$2,520.89

*Contact your local John Deere Dealer for specific part requirements and further details.

Maintain Your 7, 8, 9 (20–30 Series) Tractor



Rubber Track Belts*

NUMBER	DESCRIPTION	LIST	NOW
R545869	Camso Track Belt, 30-in., Scraper, 6500 Series	\$19,456.00	\$17,899.52
R545868	Camso Track Belt, 30-in., 6500 Series	\$18,240.00	\$16,780.80
R545867	Camso Track Belt, 30-in., 4500 Series	\$15,200.00	\$13,984.00
R545871	Camso Track Belt, 36-in., 6500 Series	\$20,976.00	\$19,297.92
R545870	Camso Track Belt, 36-in., 4500 Series	\$17,480.00	\$16,081.60
R550588	Camso Track Belt, 30-in., 3500 Series	\$10,200.00	\$ 9,384.00
R550228	Camso Track Belt, 36-in., 3500 Series	\$13,260.00	\$12,199.20
R554229	Camso Track Belt, 30-in., 6500 Series	\$12,240.00	\$11,260.80
R554230	Camso Track Belt, 36-in., 6500 Series	\$15,912.00	\$14,639.04
R550589	Camso Track Belt, Scraper, 30-in., 6500 Series	\$13,056.00	\$12,011.52
R565017	Camso Track Belt, Scraper, 18-in., 6500 Series	\$10,200.00	\$ 9,384.00
R565018	Camso Track Belt, Scraper, 24-in., 6500 Series	\$12,240.00	\$11,260.80
TR129235	Trackman by Loc® Track Belt, 18 inch Wide	\$10,868.00	\$ 9,998.56
TR130817	Trackman by Loc® Track Belt, 16 inch Wide	\$10,824.00	\$ 9,958.08
R220829	Camso Track Belt, 25-in., High Traction, 3500 Series	\$10,500.00	\$ 9,660.00
R292528	Camso Track Belt, 30-in., 3500 Series	\$12,800.00	\$11,776.00
R222976	Camso Track Belt, 18-in., 5500 Series	\$ 9,600.00	\$ 8,832.00
R312148	Camso Track Belt, 18-in., Diagonal TB (LH)	\$10,000.00	\$ 9,200.00
R312149	Camso Track Belt, 18-in., Diagonal TB (RH)	\$10,000.00	\$ 9,200.00

All applicable rubber track belts are not listed above. Please contact your local John Deere dealer to discuss our complete track belt portfolio offering.

Independent Suspension Link (ILS)

NUMBER	DESCRIPTION	LIST	NOW
RE587967	Inner Tie-Rod End	\$ 974.93	\$ 896.94
RE583653	Outer Tie Rod	\$ 694.04	\$ 638.52
RE587968	Tie-rod Assembly (Inner and Outer)	\$1,670.34	\$1,536.71
RE580643	Upper/Lower Control Arm Ball Joint	\$ 667.01	\$ 613.65
RE584459	A-Arm Upper Pivot Shaft Expander Pin	\$1,289.53	\$1,186.37
A-RE216822	Outer Tie-Rod	\$ 355.99	
A-R557917	Upper Control Arm Shaft (NEW)	\$ 491.78	

Vari-cool™ Fan Drives*

NUMBER	DESCRIPTION	LIST
RE578435	Fan Drive, Dry Driver Assembly 9L,	\$1,504.66
RE572545	Fan Drive, Dry Driven Assembly 9L,	\$ 900.14
RE587430	Fan Drive, Dry Driver Assembly 9L,	\$1,464.94
RE572544	Fan Drive, Dry Driven Assembly 9L,	\$ 859.43
RE582570	Fan Drive, Dry Driven Assembly 9L,	\$ 894.39

*Contact your local John Deere Dealer for specific part requirements and further details.

NUMBER	DESCRIPTION	LIST	NOW
R241750	Camso Track Belt, 25-in., 5500 Series	\$12,000.00	\$11,040.00
R241742	Camso Track Belt, 16.5-in., 3500 Series	\$ 7,840.00	\$ 7,212.80
R222974	Camso Track Belt, 16.5-in., Diagonal TB (RH) 5500 Series	\$ 9,408.00	\$ 8,655.36
R222975	Camso Track Belt, 16.5-in., Diagonal TB (LH) 5500 Series	\$ 9,408.00	\$ 8,655.36
R545855	Camso Track Belt, 16.5-in., Diagonal TB (RH) 6500 Series	\$11,515.00	\$10,593.80
R545854	Camso Track Belt, 16.5-in., Diagonal TB (LH) 6500 Series	\$11,515.00	\$10,593.80
R545859	Camso Track Belt, 18-in., 6500 Series	\$11,280.00	\$10,377.60
R545856	Camso Track Belt, 18-in., 4500 Series	\$ 9,400.00	\$ 8,648.00
R545860	Camso Track Belt, 24-in., 4500 Series	\$10,622.00	\$ 9,772.24
R545862	Camso Track Belt, 25-in., 6500 Series	\$12,972.00	\$11,934.24
R545861	Camso Track Belt, 25-in., 4500 Series	\$10,810.00	\$ 9,945.20
R545863	Camso Track Belt, 30-in., 4500 Series	\$12,220.00	\$11,242.40
R545872	Camso Track Belt, 30-in., Side Hill, 4500 Series	\$15,960.00	\$14,683.20
R563760	Camso Track Belt, 16.5-in., 6500 Series	\$11,054.00	\$10,169.68
R545866	Camso Track Belt, 30-in., Side Hill, 4500 Series	\$12,831.00	\$11,804.52
R545938	Camso Track Belt, 30-in., Side Hill, 4500 Series	\$13,440.00	\$12,364.80
R545939	Camso Track Belt, 25-in., Side Hill, 4500 Series	\$10,500.00	\$ 9,660.00

Maintain Your 7, 8, 9 (00-Series) Tractor



Rubber Track Belts*

NUMBER	DESCRIPTION	LIST	NOW
R257977	Camso Track Belt, 30-in., 3500 Series	\$14,000.00	\$12,880.00
R257978	Camso Track Belt, 36-in., 3500 Series	\$16,100.00	\$14,812.00
R241748	Camso Track Belt, 30-in., 5500 Series	\$16,800.00	\$15,456.00
R241749	Camso Track Belt, 36-in., 5500 Series	\$19,320.00	\$17,774.40
R241743	Camso Track Belt, 18-in., 3500 Series	\$ 8,000.00	\$ 7,360.00
R220829	CamsoTrack Belt, 25-in., High Traction, 3500 Series	\$10,500.00	\$ 9,660.00
R241745	Camso Track Belt, 25-in., 3500 Series	\$10,000.00	\$ 9,200.00
R292526	Camso Track Belt, 30-in., High Traction, 3500 Series	\$13,440.00	\$12,364.80
R292528	Camso Track Belt, 30-in., 3500 Series	\$12,800.00	\$11,776.00
R312148	Camso Track Belt, 18-in., Diagonal TB (LH)	\$10,000.00	\$ 9,200.00
R312149	Camso Track Belt, 18-in., Diagonal TB (RH)	\$10,000.00	\$ 9,200.00
R241750	CamsoTrack Belt, 25-in., 5500 Series	\$12,000.00	\$11,040.00
R241742	Camso Track Belt, 16.5-in., 3500 Series	\$ 7,840.00	\$ 7,212.80
R222974	Camso Track Belt, 16.5-in., Diagonal TB (RH) 5500 Series	\$ 9,408.00	\$ 8,655.36
R222975	Camso Track Belt, 16.5-in., Diagonal TB (LH) 5500 Series	\$ 9,408.00	\$ 8,655.36

All applicable rubber track belts are not listed above. Please contact your local John Deere dealer to discuss our complete track belt portfolio offering.

Water Pumps*

NUMBER	DESCRIPTION	LIST	NOW
RE500214	7600, 7700, 7800, 8100-8400 w/ 6076 (-009999)	\$625.70	\$575.64
SE501012	7600, 7700, 7800, 8100-8400 w/ 6076 (-009999)	\$413.19	\$380.13
A-RE500214	7600, 7700, 7800, 8100-8400 w/ 6076 (-009999)	\$368.06	
RE521502	7610-7810, 7720-7920, 8000 (010000-), 8010, 8020, 9000, 9020 W / 6081 Engine	\$590.64	\$543.39
SE501596	7610-7810, 7720-7920, 8000 (010000-), 8010, 8020, 9000, 9020 W / 6081 Engine	\$413.45	\$380.37
A-RE521502	7610-7810, 7720-7920, 8000 (010000-), 8010, 8020, 9000, 9020 W / 6081 Engine	\$210.63	



Mid & Large Tractor Starters*

NUMBER	DESCRIPTION	LIST	NOW
SE501420	7700, 7800, 8100-8300 Series	\$ 640.10	\$588.89
A-SE501420	7700, 7800, 8100-8300 Series	\$ 375.97	
RE515843	9200-9400, 9220-9620 Series	\$1,012.04	\$931.08
SE501862	9200-9400, 9220-9620 Series	\$ 682.34	\$627.75
A-RE515843	9200-9400, 9220-9620 Series	\$ 358.82	



*Contact your local John Deere Dealer for specific part requirements and further details.



Scan for more information

Reman DEF Header Now Available from JD REMAN

John Deere Reman is pleased to announce the addition of remanufactured DEF header to our product line-up. The header is available in the 12V version at a variety of lengths for multiple applications, with substantial cost savings versus that of a new replacement component. These Reman headers are upgraded to the latest design specifications to ensure they provide the performance and durability that you demand.

Reman Number	OE Number	Voltage, Header Length	Model Number	Machine Application	LIST
RM100343	DZ111096	12V, 300mm	4045, 6068	Tractor	\$1,624.21
RM100344	DZ111165	12V, 525mm	6068, 6090	Tractor	\$1,736.19
RM100345	DZ113401	12V, 525mm	6068, 6090	Combine, Sprayer	\$2,005.00
RM100346	DZ118292	12V, 300mm	4045, 6068, 6090	Tractor, Sprayer, Windrower, 4WDL, OEM	\$1,121.28
RM100347	DZ118293	12V, 400mm	6068	Tractor, Sprayer, Windrower, Backhoe	\$1,318.81
RM100348	DZ118294	12V, 525mm	6068, 6090	Tractor, Combine, Sprayer	\$1,309.13
RM100349	DZ118296	12V, 700mm	4045, 6068, 6090, 6135	Combine, Sugarcane Harvester, OEM	\$1,377.03
RM100350	DZ118670	12V, 525mm	6068, 6090	Tractor	\$1,447.10
RM100351	DZ118671	12V, 300mm	4045, 6068, 6090, 6135, 6136	Tractor, Sprayer, 4WDL, OEM	\$1,199.40
RM100352	DZ118674	12V, 600mm	4045, 6068, 6090, 6135, 6136	Tractor, Cotton Picker/Stripper, SPFH, OEM	\$ 879.21
RM100353	DZ118675	12V, 700mm	4045, 6068, 6090, 6135, 6136	Combine, Harvester, OEM	\$ 915.40



Scan for more information

Reman DEF Supply Module Now Available from JD REMAN

John Deere Reman is pleased to announce the addition of remanufactured DEF supply module to our product line-up. These Reman modules are upgraded to the latest design specifications to ensure they provide the performance and durability that your customers demand. The module comes in 12V and 24V versions used across multiple engine models and applications, with substantial cost savings versus that of a new replacement component.

Reman Number	OE Number	Model Number	Machine Application	LIST
RM100354	DZ121770	4045, 6068, 6090, 6135	12V Ag, C&F, and OEM	\$923.27
RM100340	DZ121771	4045, 6068, 6090, 6135	24V Ag, C&F, and OEM	\$915.79



Scan for more information

Reman DEF Dosing Injector Now Available from JD REMAN

John Deere Reman is pleased to announce the addition of remanufactured DEF dosing injector to our product line-up. The injector is available for multiple engine models and applications, with substantial cost savings versus that of a new replacement component. These Reman dosing injectors are upgraded to the latest design specifications to ensure they provide the performance and durability that you demand.

Reman Number	OE Number	Description	Model Number	Machine Application	LIST
RM100341	RE555626	3-hole	6090, 6135	Ag, C&F, and OEM	\$504.99
RM100342	RE560468	6-hole	4045, 6068, 6090	Ag, C&F, and OEM	\$507.87

Reman High Pressure Common Rail (HPCR) Fuel Rails Now Available from JD REMAN

John Deere Reman is pleased to announce the addition of remanufactured HPCR fuel rail assemblies to our product line-up. These assemblies provide the convenience of component exchange repair solutions, with substantial cost savings versus that of a new replacement component. These Reman components are upgraded to the latest design specifications to ensure they provide the performance and durability that you demand.



Scan for more information



Reman Number	OE Number	Model Number	Machine Application	LIST
RM100409	RE520929	4045	Ag, C&F and OEM	\$1,111.84
RM100410	RE522596	6068	Ag, C&F and OEM	\$1,236.78
RM100411	RE521433	6081	Ag, C&F and OEM	\$1,275.28
RM100412	RE521599	6090	Ag, C&F and OEM	\$1,313.91

Reman Flex Box Cab Controllers (FCC) for Tractors from JD REMAN

Flex Box Cab Controllers (FCC) are widely used on multiple tractor models. These controllers control and coordinate multiple functions related to the operator station. John Deere Reman is now able to provide a wide range of Reman solutions for the FCC controller family.

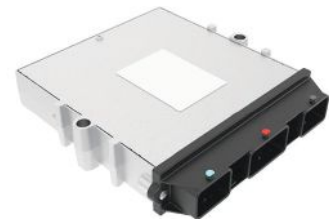

Reman Number	OE Number	Description	Machine Models	LIST
RM100371	RE266604	Electronic Control Unit, Cab Control	6D and 5E Tractors	\$ 967.63
RM100372	RE275612	Electronic Control Unit, Cab Control	7- and 8-Series Tractors	\$1,146.73
RM100373	RE275622	Electronic Control Unit, Cab Control	7-, 8-, and 9-Series Tractors	\$1,146.73
RM100375	RE309304	Electronic Control Unit, Cab Control	8R and 8RT Tractors	\$1,146.73
RM100376	AL212898	Electrohydraulic Controller, EHC	5M Tractors, Europe Edition	\$ 967.63
RM100377	SJ13216	Vehicle Controller	6B, D and E Tractors	\$ 967.63
RM100378	SJ290320	Electronic Control Unit, EHC	5-Series Tractors	\$ 967.63

Remanufactured Mid-Rollers from JD REMAN

These remanufactured polyurethane mid-rollers provide higher heat resistance compared to rubber rollers, making them more suitable for roading conditions and severe applications. John Deere remanufactured mid-rollers use original OEM steel hubs which have been cleaned, inspected, and prepped for the re-treading process. The polyurethane molding process for remanufactured mid-rollers is the same process used in new mid-roller manufacturing.



Reman Number	OE Number	Description	Where Used	LIST
RM100290	RE266293 RE576549	Narrow Rubber Mid-Roller Assembly Narrow Polyurethane Mid-Roller Assembly	8295RT, 8310RT, 8320RT, 8335RT, R8340RT, 8345RT, 8360RT, 8370RT	\$530.00
RM100291	RE254786	Mid-Roller Assembly, 126mm	8120T, 8220T, 8320T, 8420T, 8520T, 8230T, 8330T, 8430T	\$508.32
RM100292	RE576550 RE251071	Mid-Roller Assembly, Polyurethane Mid-Roller Assembly, Rubber	9430T, 9530T, 9630T, 9460RT, 9510RT, 9520RT, 9560RT, 9570RT	\$597.00
RM100370	RE575013	Mid-Roller Assembly, Polyurethane Mid-Roller Assembly	8295RT, 8310RT, 8320RT, 8335RT, R8340RT, 8345RT, 8360RT, 9470RX, 9520RX, 9570RX, 9620RX, 9RX490, 9RX540, 9RX590, 9RX640 (also includes scarper tractors)	\$618.77



Remanufactured 13.5L FT4 Complete Engine Assemblies is Available from JD REMAN

John Deere Reman has added the remanufactured 13.5L Final Tier 4 complete engine to our product line-up. This engine solution provides the convenience of component exchange repair solution, with substantial cost savings versus that of a new OEM replacement engine. John Deere Reman 13.5 L FT4 engines are remanufactured by John Deere Reman. Engines are fully disassembled, cleaned, and inspected, with ALL wear parts replaced and failed or damaged parts replaced or reconditioned as part of the reman process. Engines are upgraded to the latest design specifications. Engines are dyno tested at the reman factory to meet original OEM performance specifications. John Deere Reman 13.5L FT4 Engines carry a 2-years/2000-hour warranty (parts & labor when dealer installed). Extended Warranty coverage is also available for purchase for these complete reman engines.

Reman Part Number	REMAN CBA Part Number	Model Number	Application	LIST
RM100326	RM100318	CP690 and CS960	Cotton Picker/Stripper	\$71,133.20
RM100327	RM100318	9420R, 9470R, 9470RT, 9520R, 9520RT	Tractor	\$71,133.20
RM100328 and RM100329	RM100318	9420R, 9470R, 9470RX, 940RT, 9520R, 9520RT, 9520RX	Tractor	\$71,133.20
RM100333, RM100334, and RM100335	RM100318	8300, 8400, 8500, 8600	Self Propelled Forage Harvester (SPFH)	\$71,133.20
RM100336 and RM100337	RM100318	S680, S690	Combine	\$71,133.20
RM100338	RM100318	S680, S690, S780, S790	Combine	\$71,133.20
RM100339	RM100318	S780, S490	Combine	\$71,133.20

GREAT NEWS!!

The remanufactured 9.0L Final Tier 4 engine from JD REMAN are available! See your Dealer for specific engine details.



John Deere Electronics “Repair & Return” service from JD REMAN

Your John Deere dealer has a lower-cost repair solution for precision ag electronic components. Don't send your electronic components to just any electronics repair shop. Factory trained John Deere Reman technicians will complete the repairs. All repairs use genuine OEM parts. Components are tested back to the original OEM specifications. All repairs carry a 12-month warranty.



JDPOINT Part Number	Product Description	Repair Options	LIST
RR1800R	1800 Display, Pre-Rev E	Comprehensive Repair Only	\$ 744.01
RR2600R	2600 Display	Comprehensive Repair Only	\$ 954.91
RR2630R	2630 Display (all revisions, except J)	Comprehensive Repair Only	\$1,562.85
RR3000R	Starfire™ 3000	Comprehensive Repair, or Dome Replacement Only	\$1,405.37
RR6000R	Starfire™ 6000	Comprehensive Repair, or Top Dome Replacement Only	\$1,405.37
RR4640R	4640 Display Universal Display (10-inch)	Touchscreen Replacement Only or Touchscreen with LCD Replacement	\$1,370.80

Extended Warranty for John Deere Reman Engines*

Optional extended warranty terms for John Deere Reman engines can be purchased. Coverage options are between 2-year/2,500 hours and 5-year/4,000 hours. To qualify for the program, the engine must be dealer installed and the customer must purchase the extended warranty contract within 90 days of engine installation. Contact your John Deere Dealership for complete details.

*Complete engines only.



Announcing an even better value story. We have your back.



John Deere Reman is proud to announce that all John Deere Reman-branded **Starters and Alternators** now come with a **STANDARD** 2-year Factory warranty. Dealer-installed* or customer-installed*, you will have peace-of-mind that John Deere has your back.

2 years = Two planting and harvesting cycles. All covered by a factory warranty. Reman Tough.



Starter



Alternator



JOHN DEERE



LP82799

LP82798



LP83017



LP71701

Making Holidays Special Since 1945

ERTL® TOMY

ERTL | 2021 Ninth Street SE, Dyersville, Iowa 52040-2316 | Phone: 1.563.875.2000 | Fax: 1.563.875.5674
Ertl is a trademark of TOMY International, Inc.



Dura-Flex Bearings

John Deere Dura-Flex bearings continue to offer superior quality and consistency that is unmatched by aftermarket will-fit bearings. Introduced in 2005, they are used on disk gang assemblies and rolling baskets up to the 2600 series disks.

Dura-Flex Bearing Features:

- Includes 2-year warranty
- Built using a ball ridging, one-piece, molded nylon cage for perfect alignment
- Engineered with a thicker inner bearing race that creates a stronger cross section to withstand tough loads
- Designed with a heavy-duty bearing so the ball is harder than the rings
- Provides total clearance between rings and rolling elements for optimal load distribution and free rotation to allow for thermal expansion
- Prevents premature bearing failure with smooth rolling bearings
- Contains a chamfer in the lubrication hole to ensure proper grease flow

NUMBER	DESCRIPTION	APPLICATION	LIST
AA28184	Dura-Flex Bearing	Disks: 210, 215, 220, 230, 235, 621, 627, 630, 637 (rigid standards) Seedbed Finisher: 200 Mulch Finishers: 722, 724, 726, 2310, and 2330 Mulch Tillers: 710, 712, and 714 Field Cultivators: 980 and 2210 Air Disk Drill: 730 and 730LL	\$29.88
AA30941	Dura-Flex Bearing Kit, includes AA28184 bearing, flanges, gasket, bolts, and nuts	Disks: 210, 215, 220, 230, 235, 621, 627, 630, and 637 (rigid standards) Mulch Finisher: 712	\$44.63
AKK33315	Dura-Flex Bearing Kit, includes AA28186 bearing, flanges, gasket, bolts, and nuts	Disks: 310, 315, 330, 331, 335, 340, 350, 360, 370, 637 (C-Spring Standards), 640, and 650 Rippers: 510 and 512	\$79.01

Maintenance-Free Bearings

Maintenance-free bearings were introduced with the 2600 series disks. They are used on disk gangs and rolling baskets.

Maintenance-Free Bearing Features:

- Includes 2-year warranty
- Increases productivity by reducing the amount of required service time
- Packaged with rust-preventative paper for added protection



NUMBER	DESCRIPTION	APPLICATION	LIST
AKK16196	Maintenance-Free Bearing	Disks: 2620, 2623, 2623VT, and 2625 Rippers: 2720 and 2730	\$104.30

Extended Life Greaseable Bearing

Features & Benefits:

- Allows for limited, seasonal maintenance interval to minimize downtime
- Customized bearing maintenance for specific growing conditions and soil types
- The sealing system features improved contamination resistance



NUMBER	DESCRIPTION	APPLICATION	LIST
AKK22197	Extended Life Greaseable Bearing	Disks: 2600, 2623VT, 2630, 2633VT, and 2660VT Series	\$55.80

Cotton Parts and Attachments



Take Your Pick

All John Deere spindles are manufactured in John Deere facilities utilizing next-generation heat treat controls to create the most consistent heat-treated spindles on the market. Plus, 25 unique quality checks at 7 manufacturing points ensure the highest quality product.



For average annual usage and picking conditions, the John Deere PRO-Series Spindles offer a reliable value-priced option. For higher annual usage or harsh picking conditions, Pro-XL™ Spindles offer up to 50 percent longer life than the John Deere PRO-Series Spindles.

Individual spindles and convenient spindle assemblies are now available for both PRO and Pro-XL Spindles ... take your pick.

Spindles

- John Deere controls the entire manufacturing process including heat treatment, chroming, and quality inspections
- A unique data matrix on each spindle ensures quality control, consistency, and traceability
- Three sets of 12 barbs per flute for efficient picking
- Case hardening ensures the spindles will break and not bend when striking solid objects to minimize damage to the picking units.



NUMBER	STYLE	APPLICATION	LIST	NOW
PRO:				
KK40195	Right-hand	All John Deere Cotton Pickers	\$5.64	\$5.19
PRO-XL:				
KK28390	Right-hand	All John Deere Cotton Pickers	\$6.35	\$5.84

Spindle Assembly

Replacing worn spindles cuts the chance of stripping drive gears and damaging the picker bar. Reduce downtime by using the all-in-one, factory-made spindle assembly.

NUMBER	STYLE	APPLICATION	LIST	NOW
PRO:				
AKK24309	Right-hand	All John Deere Cotton Pickers	\$9.41	\$8.66
PRO-XL:				
AKK18840	Right-hand	All John Deere Cotton Pickers	\$9.81	\$9.03



Spindle Drive Components

Even the smallest parts of your cotton picker are designed to the highest quality standards.



NUMBER	STYLE	APPLICATION	LIST	NOW
L2456N	Bevel Drive Gear	All John Deere Cotton Pickers (except 9970, 9986, 9996, 7660, 7760, and CP690)	\$ 3.56	\$ 3.28
N371626	Bevel Drive Gear	9970, 9986, 9996, 7660, 7760, and CP690 Cotton Pickers	\$ 4.08	\$ 3.75
JD8804	Needle Bearing	All John Deere Cotton Pickers	\$ 2.04	\$ 1.88
N278037	Shaft for 18 Spindles	All John Deere Cotton Pickers (except 9970, 9986, 9996, 7660, 7760, and CP690)	\$44.01	\$40.49
N275212	Shaft for 20 Spindles	9965 and 9976 Cotton Pickers	\$53.74	\$49.44
N371572	Shaft for 20 Spindles	9986, 9996, 7660, 7760, and CP690 Cotton Pickers	\$45.47	\$41.83
N118289	14T Gear	All John Deere Cotton Pickers	\$11.31	\$ 10.41

Spindle Driveshaft Assembly

John Deere cotton pickers use hardened spindles with razor-sharp barbs rotating at high rpm. But these spindles don't work in isolation. When needed, replace the driveshaft assembly with a factory assembled shaft.



NUMBER	DESCRIPTION	APPLICATION	LIST	NOW
AN276743	18 Spindle, PRO-SERIES™	9970 Cotton Pickers and PRO-12 VRS	\$175.50	161.46
AN276737	20 Spindle	9976, 9986, 9996, 7660, 7760, and CP690 Cotton Pickers	\$252.50	232.30

Picker Bars and Assemblies

Even a bit of wear or a tiny bend reduces performance. That's why John Deere offers precisely machined components for precision performance, longer life, quick field replacement, reduced downtime, and smooth and quiet operation.



NUMBER	DESCRIPTION	APPLICATION	LIST	NOW
Bar Assembly:				
AN276740	18 Spindle	9970 Cotton Pickers and PRO-12 VRS	\$1,102.98	\$1,014.74
AN276734	20 Spindle	9976, 9986, 9996, 7660, 7760, and CP690 Cotton Pickers	\$1,025.91	\$ 943.84
Bar with Bushing and Sleeve:				
AN274501	Right-hand	9970 Cotton Pickers	\$ 185.30	\$ 170.48
AKK49979	Right-hand	9976, 9986, 9996, 7660, 7760, and CP690 Cotton Pickers	\$ 278.87	\$ 256.56

Bottom Retention Bar

This essential cotton harvesting part — the John Deere Cotton Picker Row Unit Bottom Retention Bar — comes from the highest grade of lightweight aluminum and is seamless so they do not split, providing a large range of flexibility to bend under demanding field conditions. These features help reduce downtime, input costs, and unnecessary repairs.



NUMBER	DESCRIPTION	LIST	NOW
AKK41952	Bottom Retention Bar	\$1,025.91	\$943.84

Doffers, Doffer Parts, and Doffer Assemblies

John Deere urethane doffers greatly reduce contamination and offer increased wear life. They're specially designed for balanced, smooth operation—even at high speeds. Our doffers are precision engineered to reduce the need for grinding or shimming and are heat- and oil-resistant. Save time with ready-to-install doffer assemblies straight from the factory!

NUMBER	DESCRIPTION	MODEL	LIST	NOW
AN406038	Urethane Doffer	CP690 Cotton Pickers (hollow-core shaft)	\$ 13.13	\$ 12.08
AN272152	Urethane Doffer	Cotton Pickers including 9986, 9996, 7660, and 7760 (solid shaft)	\$ 13.13	\$ 12.08
AN273953	Column Housing	All John Deere Cotton Pickers	\$ 78.12	\$ 71.87
JD10123	Shaft Ball Bearing	John Deere Cotton Pickers (except 9970, 9976, 9986, 9996, 7660, 7760, and CP690)	\$ 18.45	\$ 16.97
L3197N	Shim	All John Deere Cotton Pickers	\$ 0.54	\$ 0.50
Assembly with Urethane Doffers:				
AN274508	Doffer Assembly	Pro 12 and Pro 12 VRS Row Units	\$648.52	\$596.64
AKK17562	Doffer Assembly	Cotton Pickers including 9986, 9996, 7660, 7760, and CP690 (Pro-16 row units)	\$794.18	\$730.65



Moistener Pads

These specially designed pads feature an X pattern to ensure proper moisture distribution on picking spindles operating in all types of conditions. Precise fins provide an even flow of cleaner from the pad to the spindle, ensuring optimum picking performance. Pads are made of long-lasting urethane. A tight fit keeps debris from plugging the moistener system or tearing the pad off during harvest.

NUMBER	DESCRIPTION	LIST	NOW
N275607	Urethane Moistener Pad	\$2.77	\$2.55



Pressure and Scrapping Plates

Our pressure plates, pressure plate extensions, and scrapping plates provide a profile that will keep the cotton plant in the picking zone longer, giving the spindle more opportunity to harvest the cotton off the plant.

NUMBER	DESCRIPTION	APPLICATION	LIST	NOW
Pressure Doors:				
AN279557	Pressure Door, PRO-12™ Units, Front and Rear (2-per row)	9 970 Cotton Pickers and PRO-12 VRS	\$335.39	\$308.56
AN279558	Pressure Door, PRO-16™ Units, Front (1-per row)	9 976, 9986, 9996, 7660, 7760, and CP690 Cotton Pickers	\$368.15	\$338.70
Pressure Plate Extensions:				
N278127	Extension, Pressure Plate, PRO-12 (2-per row)	9970 Cotton Pickers and PRO-12 VRS	\$ 67.23	\$ 61.85
N274103	Extension, Pressure Plate, PRO-16 (2-per row)	9976, 9986, 9996, 7660, 7760, and CP690 Cotton Pickers	\$ 71.78	\$ 66.04
Scrapping Plates:				
N372970	Scrapping Plate (10-spindle), PRO-12 (2-per row), PRO-16 (4-per row)	9970, 9976, 9986, 9996, 7660, 7760, and CP690 Cotton Pickers	\$ 71.54	\$ 65.82
N372971	Scrapping Plate (4-spindle), PRO-12 (4-per row)	9970, 7660, 7760, and CP690 Cotton Pickers and PRO-12 VRS	\$ 45.86	\$ 42.19



Round Module Builder (RMB) Belts



NUMBER	DESCRIPTION	APPLICATION	LIST	NOW
A-1012095	Narrow Belt – 5 Used	7760, CP690, CS690	\$ 881.51	\$ 810.99
AN373217	Narrow Belt – 5 Used	7760, CP690, CS690	\$1,032.31	\$ 949.73
A-1012096	Wide Belt – 6 Used	7760, CP690, CS690	\$ 971.34	\$ 893.63
AKK23004	Wide Belt – 6 Used	7760, CP690, CS690	\$1,218.12	\$ 1,120.67

Essential lubricants

John Deere Spindle Cleaner and Grease boost your harvesting performance and reduce your operating and maintenance costs.

■ Spindle Cleaner

Spindle Cleaner protects your cotton picker's mechanical parts from rust, oxidation, and corrosion—yet it won't wash spindle grease off bushings and attachments.

■ Spindle Grease

John Deere Spindle Grease is an all-in-one, lithium-based lubricating grease, gear lubricant, penetrating oil, and corrosion protector. It reduces the amount of wear from metal-to-metal contact in your picker head, and it extends the service life of high-wear parts.

Call us today to learn more.



Spindle Grease and Cleaner



NUMBER	DESCRIPTION	LIST	NOW
Spindle Grease			
AN113719	30-lb.	\$ 142.24	\$ 130.86
AN31360	120-lb.	\$ 448.32	\$ 412.45
TY25845	2,000-lb.	\$6,190.67	\$ 5,695.42
Spindle Cleaner			
AN114022	5-Gallon	\$ 151.60	\$ 139.47
AN114023	55-Gallon	\$1,526.04	\$ 1,403.96

Inspections Include The Kit And The Caboodle









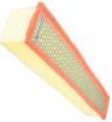

Just about everything. That's what you get with a **COTTON HARVESTER INSPECTION** from your John Deere dealer. Providing **more than 100 checkpoints**, our comprehensive service will help you experience a more successful harvest. We'll inspect the **15 primary areas** of your machine, including:

- Operator's Station
- Fuel System
- Fluids
- Steering & Brakes
- Engine
- Cooling System
- Electrical
- Hydraulic System
- Accumulator
- Feeder
- On-Board Module Builder
- Wrap System & Handler
- Moistener System
- Air System
- Row Unit Attachments

Schedule your cotton harvester inspection with us today!

REPLACEMENT PARTS GUIDE

CP770 Cotton Picker

<p>CAB</p> <p>FRESH AIR FILTER RE284091</p> <p>Clean or replace every 50 hours or as required. If operating in dusty conditions clean daily.</p>		<p>ENGINE</p> <p>FUEL TANK BREATHER H216169</p> <p>Replace every 2000 hours.</p>	<p>RECIRCULATION AIR FILTER AXE70605</p> <p>Clean or replace every 250 hours or as required. If operating in dusty conditions clean daily.</p>		<p>OIL FILTER RE527285</p> <p>Minimum hours before first engine oil change is 100 hours. Extended engine oil change every 375 hours or annually, whichever come first. The extended 375 hour interval is only allowed if using Plus-50™ II oil with a John Deere filter and diesel fuel with sulfur content less than 15mg/kg (15ppm). If all conditions are not met, change oil and filter at 250 hours of operation.</p>
<p>ENGINE</p> <p>PRIMARY FUEL FILTER DZ124761</p> <p>Replace every 400 hours or annually, whichever occurs first.</p>		<p>DIESEL EXHAUST FLUID DOSING FILTER DZ114640</p> <p>Replace after first 1500 hours or 3 years, whichever occurs first.</p>	<p>SECONDARY FUEL FILTER DZ124786</p> <p>Replace every 400 hours or annually, whichever occurs first.</p>		<p>DIESEL EXHAUST FLUID IN-LINE FILTER DZ124403</p> <p>Replace after first 1500 hours or 3 years, whichever occurs first.</p>
<p>PRIMARY AIR FILTER HXE11090</p> <p>Replace every 400 hours or as required.</p>		<p>HYDRAULICS</p> <p>PROPEL PUMP CHARGE FILTER RE273801</p> <p>Replace every 1000 hours.</p>	<p>SECONDARY AIR FILTER HXE11091</p> <p>Replace every 400 hours or annually, whichever occurs first.</p>		<p>CHASSIS RETURN OIL FILTER AKK33523</p> <p>Replace every 1000 hours.</p>
<p>HYDRAULICS</p> <p>PUMP FILTER AKK43338</p> <p>Replace every 1000 hours.</p>		<p>UNIT GREASE SYSTEM</p> <p>LUBRICATION SYSTEM FILER AN192848 (2)</p> <p>Replace every 250 hours.</p>	<p>SECONDARY AIR FILTER HXE11091</p> <p>Replace every 400 hours or annually, whichever occurs first.</p>		<p>AUXILIARY GEAR CASE OIL FILTER AKK28711</p> <p>Replace every 1000 hours.</p>
<p>HYDRAULICS</p> <p>PUMP FILTER AKK43338</p> <p>Replace every 1000 hours.</p>		<p>FUEL PRECLEANER FILTER R502778</p> <p>Replace every 400 hours or annually, whichever occurs first.</p>			

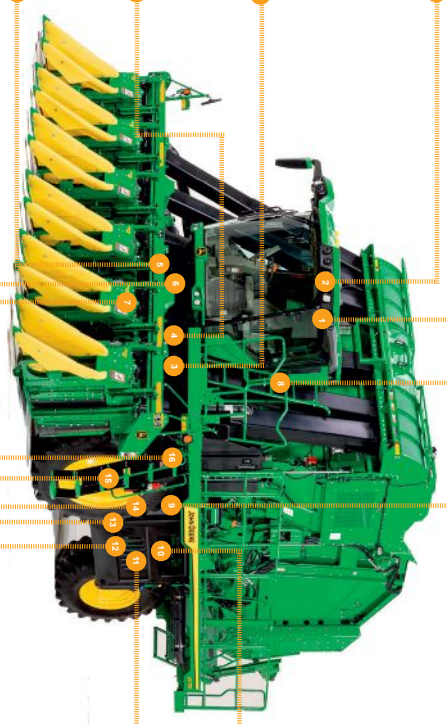

Scan to access additional
Quick Reference Guides

Stalklifter Rods

Stalklifter rods allow you to harvest low-hanging bolls more easily by improving the row unit's lifting action.



NUMBER	MODEL	LIST	NOW
BN272534	PRO-12, PRO-16, VRS Units	\$497.20	\$457.42

Scrapping Plates

Scrapping plates boost harvest efficiency by pushing cotton further into the spindle picking zone.



NUMBER	MODEL	LIST	NOW
BN272408	PRO-16 Units	\$379.50	\$349.14

Active RMB Belt Cleaning Brush

The CP690 offers an optional active rotating belt cleaning brush that provides improved RMB belt cleaning in tougher, higher-moisture harvesting conditions.

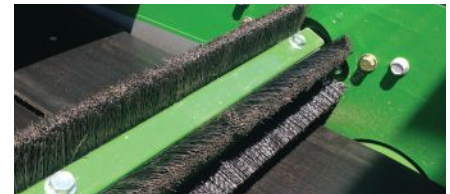

NUMBER	MODEL	LIST	NOW
BKK10319	CP690, CS690	\$3,740.00	\$3,440.80

Spring Tension Feeder Belt Kit

Proper adjustment of the cotton feeder belt is critical for performance and reliability of the round module cotton harvester. If the feeder belt tension is set too loose, the belt can slip. If it is set too tight, damage to the lace and/or belt can occur. The spring tension feeder belt kit makes it easier to properly set the feeder belt tension during machine operation.



NUMBER	MODEL	LIST	NOW
AKK21021	7760, CP690, CS690	\$4,113.91	\$3,784.80

Mud Scrapers

Mud scrapers may be installed to help clean drive tires in muddy conditions.



NUMBER	MODEL	LIST	NOW
KK24399	7760, CP690, CS690	\$484.72	\$445.94
KK24400	7760, CP690, CS690	\$506.20	\$465.70
N380682	7760, CP690, CS690	\$ 77.04	\$ 70.88
N380870	7760, CP690, CS690	\$299.25	\$275.31

Harvest Identification, Cotton Pro

Harvest Identification, Cotton Pro is the next generation of round module tracking. Features include the documentation of module moisture, weight, editable features, and other features. Cotton module weighing provides on-the-go cotton module weights to the cab display that enables easier yield monitor calibration for more accurate harvest yield data and agronomic decisions. Cotton module moisture sensor provides a vital role in preserving cotton quality and maintain high quality standards.

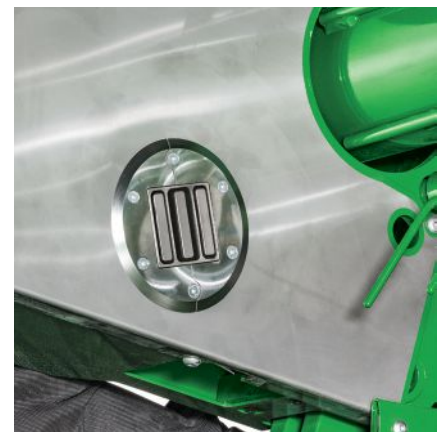

NUMBER	DESCRIPTION	LIST	NOW
Harvest Identification, Cotton Pro – CP690 and CS690 (MY17+):			
BKK11493	Cotton Pro Kit (RFID Reader)	\$1,501.73	\$1,381.59
Cotton Module Weighing – CP690 and CS690 (MY15–16):			
AKK34834	Cotton Module Weighing Kit	\$4,251.00	\$3,910.92
Cotton Moisture Sensor – CP690 and CS690 (MY15–16):			
AKK25968	Moisture Sensor Kit	\$3,100.00	\$2,852.00

Cotton Stripper Bats and Brushes

Worn bats and brushes leave more cotton in the field and less in your module. To ensure peak harvesting efficiency, you'll want to monitor their condition and replace worn components. John Deere cotton stripper bats and brushes are manufactured from the highest quality raw materials. Their steel channels are electro-galvanized to prevent rust. Finally, products are thoroughly inspected to ensure quality.



NUMBER	DESCRIPTION	LENGTH	LIST	NOW
Bats				
AN123046	1-Ply Bat	40-in.	\$14.45	\$13.29
AN122821	1-Ply Bat	40-in.	\$10.95	\$10.07
Row Unit Brushes				
KK72054	Stripper Brush	10-in.	\$ 2.79	\$ 2.57
KK72055	Stripper Brush	20-in.	\$ 4.52	\$ 4.16
KK72056	Stripper Brush	20-in.	\$ 6.65	\$ 6.12
KK72057	Mud Brush	40-in.	\$ 8.89	\$ 8.18
Cleaner Brushes				
AN221023	Doffer Brush – 2-in. Trim	59.25-in.	\$14.53	\$13.37
AN221813	Doffer Brush – 1 ⁷ / ₈ -in. Trim	59.25-in.	\$13.81	\$12.71
AN221683	Notched Reclaimer (landlord brush)	59.375-in.	\$42.59	\$39.18
AN123628	3-in. Burr Reclaimer	59.5-in.	\$46.81	\$43.07
AN123721	Doffer Brush	59.5-in.	\$11.52	\$10.60
AN220747	Burr Reclaimer (fire brush)	59.5-in.	\$42.59	\$39.18
AKK11599	Brush CS690 Cleaner Air Duct	11-in.	\$ 2.67	\$ 2.46
AKK11600	Brush CS690 Cleaner Air Brush	20-in.	\$ 7.01	\$ 6.45
Whiskers				
AN122263	Cat Whisker	9-in.	\$ 5.04	\$ 4.64
AN221395	Cat Whisker w/o Notches	9-in.	\$ 4.97	\$ 4.57
AN123821	Cat Whisker	22-in.	\$14.16	\$13.03
AN273317	Cat Whisker w/o Notches	37.5-in.	\$17.29	\$15.91
AN220022	Cat Whisker w/o Notches	48-in.	\$28.03	\$25.79
AN221228	Cat Whisker w/o Notches	52-in.	\$33.25	\$30.59

Cotton Stripper Saw Blades and Drums

John Deere saw blades feature a consistent tooth profile spacing for even cleaning and rugged performance. Saw blades are heat-treated for excellent tooth rigidity and long life.



NUMBER	DESCRIPTION	LIST	NOW
Saw Blades:			
N221590	Regular Tooth	\$ 4.87	\$ 4.48
Complete Saw Drum Assembly:			
AN220732	7445, 7450, 7455, 7460	\$2,162.42	\$1,989.43
AN405199	CS690	\$2,309.39	\$2,124.64

Is your SPFH “good-to-go” for harvest?



Find out with a comprehensive inspection from John Deere.

Get the most from your Self-Propelled Forage Harvester (SPFH) this season with a comprehensive inspection from John Deere. Our certified technicians can save you time and money by prepping your machine for the long haul before ever heading out to the field. So inspect now to minimize downtime in the future.

Call us today to schedule your appointment.

Get ready for the season ahead

An SPFH inspection from a John Deere technician covers the most vital aspects of your machine, including:

- Engine, Cooling, & Fuel Systems
- Steering & Brakes
- Electrical
- Hydraulic Systems
- Operator's Station
- Safety
- Feedroll Housing
- Metal Detector
- Cutterhead
- Kernel Processor
- Spout
- Blower

Make an appointment today.

SPFH Windrow Pickups Parts and Attachments



Pickup Teeth

NUMBER	DESCRIPTION	LIST	NOW
630A, 640A, 645A, 630B, 640B, 645B:			
CC25176	Teeth	\$6.06	\$5.58
639 Standard Pickup:			
LCA105173	Teeth – Standard	\$3.95	\$3.63
639, 649, 659 Premium Pickup:			
LCA108554	Teeth – Premium	\$5.50	\$5.06

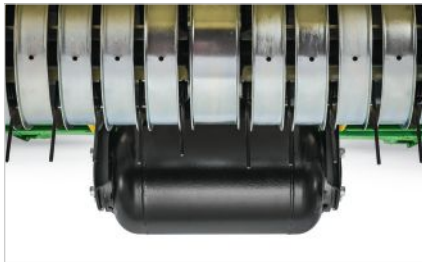

Pickup Strippers

NUMBER	DESCRIPTION	LIST	NOW
630A, 640A, 645A (-052096):			
E65648	Stripper	\$71.90	\$66.15
630A, 640A, 645A (052097-):			
FH311772	Stripper	\$43.79	\$40.29
630B, 640B, 645B:			
FH311772	Stripper	\$43.79	\$40.29
639, 649, 659:			
LCA104898	Stripper	\$32.22	\$29.64

Cam, Cam Arm, Cam Follower



NUMBER	DESCRIPTION	LIST	NOW
630A, 640A, 645A:			
CC44956	Cam LH	\$311.24	\$286.34
CC44955	Cam RH	\$311.26	\$286.36
AE46215	Cam Follower/Bearing	\$ 31.99	\$ 29.43
LCA126807	Cam Arm	\$147.92	\$136.09
LCA126808	Cam Arm	\$116.03	\$106.75
630B, 640B, 645B:			
CC44956	Cam LH	\$311.24	\$286.34
CC44955	Cam RH	\$311.26	\$286.36
AE46215	Cam Follower/Bearing	\$ 31.99	\$ 29.43
LCA126807	Cam Arm	\$147.92	\$136.09
LCA126808	Cam Arm	\$116.03	\$106.75
LCA116587	Cam Arm LH (106601-)	\$ 80.47	\$ 74.03
639 Standard Pickup:			
CC44956	Cam LH	\$311.24	\$286.34
CC44955	Cam RH	\$311.26	\$286.36
AFH204000	Cam Follower/Bearing	\$ 33.76	\$ 31.06
LCA116588	Cam Arm	\$ 74.87	\$ 68.88
639, 649, 659 Premium Pickup:			
FH316226	Cam LH	\$481.09	\$442.60
FH316225	Cam RH	\$481.09	\$442.60
LCA108964	Cam Arm w/Bearing	\$165.91	\$152.64
LCA108965	Cam Arm w/Bearing	\$165.91	\$152.64

7000-Series SPFH Parts and Attachments

7780

Feeding Parts – 7000-Series

John Deere feed rolls, wear strips, and bolts are made from heavy-duty, induction hardened stainless steel, which helps to minimize potential downtime. They are also demagnetized to prevent them from false tripping the metal detection system.



NUMBER	DESCRIPTION	LIST	NOW
--------	-------------	------	-----

7200, 7300, 7400, 7500, 7250, 7350, 7450, 7550, 7180, 7280, 7380, 7480, 7580:

Upper Front Feed Roll:

AZ103443	Feed Roll with Replaceable Wear Strips	\$2,708.70	\$2,492.00
HXE64649	Wear Strip – Corn	\$ 89.07	\$ 81.94
HXE64652	Wear Strip – Grass	\$ 160.58	\$ 147.73
Z81671	Shaft	\$ 540.15	\$ 496.94
JD10071	Needle Bearing	\$ 23.72	\$ 21.82
AZ62417	Needle Bearing	\$ 26.32	\$ 24.21
AL28870	Seal	\$ 20.22	\$ 18.60

Upper Rear Feed Roll:

AZ71834	Feed Roll	\$ 977.00	\$ 898.84
HXE26048	Shaft	\$ 240.04	\$ 220.84
JD10458	Bearing	\$ 63.48	\$ 58.40

Lower Feed Roll:

AZ101149	Feed Roll	\$1,802.96	\$1,658.72
Z77138	Shaft (783 MM)	\$ 755.40	\$ 694.97
HXE32390	Shaft (728 MM)	\$ 447.04	\$ 411.28
AZ51405	RH Bearing	\$ 86.20	\$ 79.30
AXE10405	LH Outside Bearing	\$ 75.25	\$ 69.23
JD9467	LH Inside Bearing	\$ 18.54	\$ 17.06

7700, 7800, 7750, 7850, 7950, 7780, 7980:

Upper Front Feed Roll:

AZ103444	Feed Roll with Replaceable Wear Strips (7700/7800)	\$4,011.05	\$3,690.17
AZ103444	Feed Roll with Replaceable Wear Strips (7750, 7850, 7950, 7780, 7980)	\$4,011.05	\$3,690.17
HXE64650	Wear Strip – Corn	\$ 123.53	\$ 113.65
HXE64653	Wear Strip – Grass	\$ 201.80	\$ 185.66
Z81672	Shaft	\$ 565.90	\$ 520.63
JD10071	Needle Bearing	\$ 23.72	\$ 21.82
AZ62417	Needle Bearing	\$ 26.32	\$ 24.21
AL28870	Seal	\$ 20.22	\$ 18.60

Upper Rear Feed Roll:

AZ71837	Feed Roll	\$1,389.19	\$1,278.05
HXE26049	Shaft	\$ 316.77	\$ 291.43
JD10458	Bearing	\$ 63.48	\$ 58.40

Lower Feed Roll:

AZ101150	Feed Roll	\$2,688.93	\$2,473.82
Z102377	Shaft (848 MM)	\$ 726.99	\$ 668.83
AZ51405	RH Bearing	\$ 86.20	\$ 79.30
AXE10405	LH Outside Bearing	\$ 75.25	\$ 69.23
JD9467	LH Inside Bearing	\$ 18.54	\$ 17.06

Cutting Parts – 7000-Series



Knives

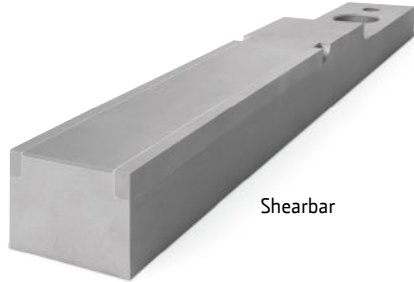

Shearbar

NUMBER	DESCRIPTION	LIST	NOW
7200, 7300, 7400, 7500, 7250, 7350, 7450, 7550, 7180, 7280, 7380, 7480, 7580:			

Knives and Mounting Parts:

Z63136	Corn Knife	\$ 30.50	\$ 28.06
Z62075	Corn Knife, Angled, Right-Hand	\$ 34.46	\$ 31.70
Z62076	Corn Knife, Angled, Left-Hand	\$ 34.46	\$ 31.70
Z69500	Grass Knife	\$ 27.72	\$ 25.50
Z102741	Grass Knife, Dura Line™ Coated	\$ 35.35	\$ 32.52
Z69650	Knife Bolt	\$ 3.04	\$ 2.80
Z60535	Cover Plate	\$ 12.27	\$ 11.29
HXE121397	Thread Bar	\$ 31.15	\$ 28.66
Z101528	Knife Bracket	\$ 17.00	\$ 15.64

Shearbars/Stationary Knife:

AZ53906	Corn	\$ 690.06	\$ 634.86
AZ103112	Grass	\$ 690.06	\$ 634.86
AZ57685	All Crop, Heavy-Duty	\$1,032.15	\$ 949.58
AXE37631	All Crop, Dura Line™ Plus	\$1,879.73	\$1,729.35

7700, 7800, 7750, 7850, 7950, 7780, 7980:

Knives and Mounting Parts:

Z72500	Corn Knife	\$ 33.90	\$ 31.19
Z81123	Grass Knife	\$ 30.50	\$ 28.06
Z103040	Grass Knife, Dura Line™ Coated	\$ 39.26	\$ 36.12
Z69650	Knife Bolt	\$ 3.04	\$ 2.80
Z76801	Cover Plate	\$ 13.41	\$ 12.34
HXE121393	Thread Bar	\$ 36.42	\$ 33.51
Z101529	Knife Bracket	\$ 124.25	\$ 114.31

Shearbars/Stationary Knife:

AZ64735	Corn	\$ 815.71	\$ 750.45
AZ103113	Grass	\$ 799.72	\$ 735.74
AZ64737	All Crop, Heavy-Duty	\$1,603.89	\$1,475.58
AXE37632	All Crop, Dura Line™ Plus	\$1,993.89	\$1,834.38

7000, 7050, 7080:

Sharpening Stone:

AZ56626	Stone	\$ 124.26	\$ 114.32
---------	-------	-----------	-----------

Crop Flow Parts – 7000-Series



Spiral Band

NUMBER	DESCRIPTION	LIST	NOW
7200, 7300, 7400, 7500, 7250, 7350, 7450, 7550, 7180, 7280, 7380, 7480, 7580:			

Spiral Band:

AXE40436	Standard	\$ 358.05	\$ 329.41
AXE40438	Dura Line™	\$1,468.64	\$1,351.15

Grass Chute:

AZ65662	Grass Chute, Bottom	\$ 298.82	\$ 274.91
Z78611	Stainless Steel Wear Liner	\$ 268.79	\$ 247.29

7700, 7800, 7750, 7850, 7950, 7780, 7980:

Spiral Band:

AXE40437	Standard	\$ 537.26	\$ 494.28
AXE40439	Dura Line™	\$1,602.37	\$1,474.18

Grass Chute:

AZ65663	Grass Chute, Bottom	\$ 350.87	\$ 322.80
Z78792	Stainless Steel Wear Liner	\$ 256.57	\$ 236.04

Blower Parts – 7000-Series

NUMBER	TYPE	DESCRIPTION	LIST	NOW
7200, 7300, 7400, 7500, 7250, 7350, 7450, 7550, 7180, 7280, 7380, 7480, 7580:				
HXE29868	Paddles	Straight – Normal Conditions (10 used)	\$ 33.25	\$ 30.59
HXE34827	Paddles	Serrated – Gummy Conditions (5 used)	\$ 34.31	\$ 31.57
HXE34828	Paddles	Serrated – Gummy Conditions (5 used)	\$ 34.31	\$ 31.57
Z67028	Blower Band	Standard	\$ 124.50	\$ 114.54
Z105384	Blower Band	Dura Line™	\$ 899.60	\$ 827.63
7700, 7800, 7750, 7850, 7950, 7780, 7980:				
HXE29814	Paddles	Straight – Normal Conditions (10 used)	\$ 39.06	\$ 35.94
HXE34825	Paddles	Serrated – Gummy Conditions (5 used)	\$ 39.70	\$ 36.52
HXE34826	Paddles	Serrated – Gummy Conditions (5 used)	\$ 39.70	\$ 36.52
Z73473	Blower Band	Standard	\$ 257.34	\$ 236.75
Z105386	Blower Band	Dura Line™	\$1,287.10	\$1,184.13



Blower Band

Transition Chute Parts – 7000-Series

NUMBER	DESCRIPTION	LIST	NOW
7200, 7300, 7400, 7500, 7250, 7350, 7450, 7550, 7180, 7280, 7380, 7480, 7580:			
AZ104287	Chute	\$2,335.09	\$2,148.28
AZ104286	Wear Plate Kit	\$ 638.15	\$ 587.10
7700, 7800, 7750, 7850, 7950, 7780, 7980:			
AXE25702	Chute	\$2,611.42	\$2,402.51
AZ104208	Front Wear Plate Kit	\$ 461.09	\$ 424.20
AZ104209	Rear Wear Plate Kit	\$ 416.77	\$ 383.43



Spout Parts – 7000-Series

NUMBER	TYPE	DESCRIPTION	LIST	NOW
7000, 7050, 7080:				
AZ104282	High-Arc Spout	Spout without Wear Liners	\$4,626.96	\$4,256.80
AZ104285	High-Arc Spout	Spout Extension – Standard	\$ 286.91	\$ 263.96
BZ100238	High-Arc Spout	Spout Extension – 8-Row	\$ 896.50	\$ 824.78
BZ100239	High-Arc Spout	Spout Extension – 10-Row	\$1,736.90	\$1,597.95
AZ103510	High-Arc Spout	Wear Liner – Bottom (848 MM)	\$ 216.97	\$ 199.61
AZ102629	High-Arc Spout	Wear Liner – Bottom (Dura Line™)	\$ 631.15	\$ 580.66
AZ103381	High-Arc Spout	Wear Liner – Middle (1,800 MM)	\$ 205.04	\$ 188.64
AZ103382	High-Arc Spout	Wear Liner – Middle (1,800 MM) w/NIR	\$ 307.37	\$ 282.78
AZ101740	High-Arc Spout	Wear Liner – Middle (2,000 MM) w/NIR	\$ 284.12	\$ 261.39
AZ54609	High-Arc Spout	Wear Liner – Top	\$ 141.56	\$ 130.24
AZ101238	Low-Arc Spout	Spout – Bottom	\$4,625.09	\$4,255.08
AZ101239	Low-Arc Spout	Spout – Middle	\$2,125.71	\$1,955.65
AZ101240	Low-Arc Spout	Spout – Top	\$1,062.02	\$ 977.06
Z68680	Flaps	Wear Liner – Bottom	\$ 169.36	\$ 155.81
Z105385	Flaps	Wear Liner – Bottom (Dura Line™)	\$ 969.54	\$ 891.98
Z105390	Flaps	Wear Liner – Bottom (Dura Line™) w/NIR	\$1,006.83	\$ 926.28
AZ54380	Flaps	Middle Flap	\$ 108.19	\$ 99.53
AZ100715	Flaps	Middle Flap (Dura Line™)	\$ 698.92	\$ 643.01
AZ53234	Flaps	End Flap	\$ 107.43	\$ 98.84
AZ100714	Flaps	End Flap (Dura Line™)	\$ 670.22	\$ 616.60

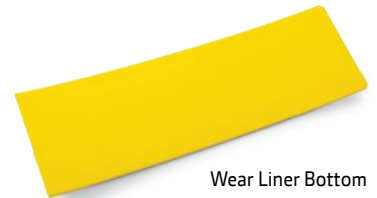

Wear Liner Bottom



Middle Flap

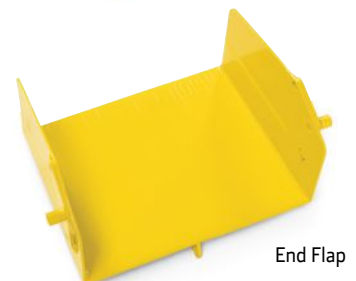

End Flap

8000/9000-Series SPFH Parts and Attachments

8800

Feeding Parts – 8000/9000-Series

On both front feed rolls (upper and lower) each wear bar is reversible (straight or serrated edge) so you can adjust the aggressiveness of crop feeding.



NUMBER	TYPE	DESCRIPTION	LIST	NOW
8100, 8200, 8300, 8400, 8500:				
AXE49885	Upper Front Feed Roll	Feed Roll	\$3,949.36	\$3,633.41
HXE93580	Upper Front Feed Roll	Steel Wear Strip	\$ 149.73	\$ 137.75
HXE87701	Upper Front Feed Roll	Plastic Strip	\$ 45.81	\$ 42.15
HXE100098	Lower Front Feed Roll	Steel Wear Strip	\$ 149.73	\$ 137.75
AXE66457	Upper Front Feed Roll	Feed Roll (-516999)	\$ 830.86	\$ 764.39
AXE66457	Upper Front Feed Roll	Feed Roll (517000-)	\$ 830.86	\$ 764.39
AXE14074	Lower Front Feed Roll	Feed Roll	\$ 839.75	\$ 772.57
8600, 8700, 8800, 9600, 9700, 9800, 9900:				
AXE85661	Upper Front Feed Roll	Feed Roll	\$2,671.72	\$2,457.98
HXE93575	Upper Front Feed Roll	Steel Wear Strip	\$ 144.04	\$ 132.52
HXE87459	Upper Front Feed Roll	Plastic Strip	\$ 78.41	\$ 72.14
AXE77419	Lower Front Feed Roll	Feed Roll	\$5,482.15	\$5,043.58
HXE100097	Lower Rear Feed Roll	Steel Wear Strip	\$ 132.40	\$ 121.81
AXE66456	Upper Front Feed Roll	Feed Roll (-516999)	\$1,023.76	\$ 941.86
AXE66456	Upper Front Feed Roll	Feed Roll (517000-)	\$1,023.76	\$ 941.86
AXE14946	Lower Rear Feed Roll	Feed Roll	\$ 939.63	\$ 864.46
8000, 9000-Series:				
HXE87510	Feed Roll Wear Strips Hardware	Upper Strip Screw	\$ 2.87	\$ 2.64
Z74127	Feed Roll Wear Strips Hardware	Lower Strip Screw	\$ 2.00	\$ 1.84
Z74128	Feed Roll Wear Strips Hardware	Nut	\$ 2.40	\$ 2.21

Cutting Parts – 8000/9000-Series

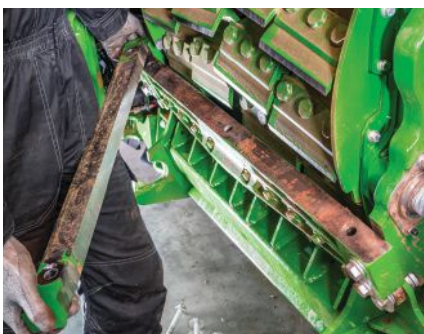

NUMBER	TYPE	DESCRIPTION	LIST	NOW
8100, 8200, 8300, 8400, 8500:				
HXE185152	Knives and Mounting Parts	Corn Knife	\$ 36.70	\$ 33.76
HXE185150	Knives and Mounting Parts	Grass Knife	\$ 33.63	\$ 30.94
HXE143972	Knives and Mounting Parts	Knife Bolt	\$ 4.14	\$ 3.81
HXE121397	Knives and Mounting Parts	Thread Bar	\$ 31.15	\$ 28.66
HXE53563	Knives and Mounting Parts	Knife Bracket	\$ 99.92	\$ 91.93
HXE142406	Shearbars / Stationary Knife	Corn	\$ 810.83	\$ 745.96
HXE142407	Shearbars / Stationary Knife	Grass	\$ 943.65	\$ 868.16
HXE172985	Shearbars / Stationary Knife	All Crop, Dura Line™ Plus	\$2,711.73	\$2,494.79
8600, 8700, 8800, 9600, 9700, 9800, 9900:				
HXE185151	Knives and Mounting Parts	Grass Knife	\$ 37.12	\$ 34.15
HXE143972	Knives and Mounting Parts	Knife Bolt	\$ 4.14	\$ 3.81
HXE121393	Knives and Mounting Parts	Thread Bar	\$ 36.42	\$ 33.51
HXE52928	Knives and Mounting Parts	Knife Bracket	\$ 130.06	\$ 119.66
HXE142408	Shearbars / Stationary Knife	Corn Knife	\$ 777.98	\$ 715.74
HXE142409	Shearbars / Stationary Knife	Grass Knife	\$ 777.98	\$ 715.74
HXE169399	Shearbars / Stationary Knife	All Crop, Dura Line™ Plus	\$3,511.85	\$3,230.90
HXE171640	Shearbars / Stationary Knife	Corn, Dura Line™	\$1,512.11	\$1,391.14
8000, 9000-Series:				
AXE17437	Sharpening Stone	Stone	\$ 142.14	\$ 130.77

Blower Parts – 8000/9000 Series

NUMBER	DESCRIPTION	LIST	NOW
HXE37067	Straight – Normal Conditions (10 used)	\$ 43.43	\$ 39.96
HXE34827	Serrated – Gummy Conditions (5 used)	\$ 34.31	\$ 31.57
HXE34828	Serrated – Gummy Conditions (5 used)	\$ 34.31	\$ 31.57
AXE41235	Standard	\$ 648.62	\$ 596.73
AXE42112	Dura Line™	\$2,350.50	\$2,162.46
HXE29814	Straight – Normal Conditions (10 used)	\$ 39.06	\$ 35.94
HXE34825	Serrated – Gummy Conditions (5 used)	\$ 39.70	\$ 36.52
HXE34826	Serrated – Gummy Conditions (5 used)	\$ 39.70	\$ 36.52
AXE35811	Standard	\$ 690.82	\$ 635.55
AXE42114	Dura Line™	\$2,741.69	\$2,522.35

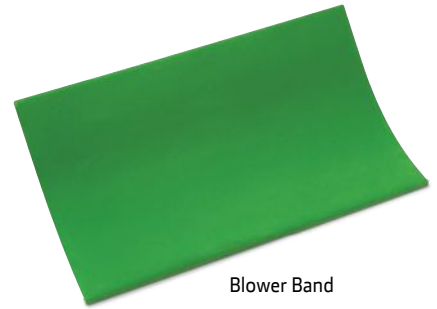

Blower Band

Spout Parts – 8000/9000-Series

NUMBER	DESCRIPTION	LIST	NOW
8000/9000-Series:			
High-Arc Spout:			
BXE11033	Spout Extension – 10-Row	\$4,783.90	\$4,401.19
BXE11098	Spout Extension – 12-Row	\$6,565.90	\$6,040.63
HXE144911	Wear Liner – Bottom	\$ 375.14	\$ 345.13
HXE144912	Wear Liner – Bottom (Dura Line™)	\$1,317.01	\$1,211.65
AXE25517	Wear Liner – Middle	\$ 186.42	\$ 171.51
HXE39391	Wear Liner – Top	\$ 271.11	\$ 249.42
Low-Arc Spout:			
AXE75118	Spout – Bottom	\$7,862.88	\$7,233.85
AZ101239	Spout – Middle	\$2,125.71	\$1,955.65
AZ101240	Spout – Top	\$1,062.02	\$ 977.06
AXE48208	Wear Liner – Bottom	\$ 478.24	\$ 439.98
AXE49258	Wear Liner – Bottom (Dura Line™)	\$1,375.05	\$1,265.05
AXE45366	Wear Liner – Top	\$ 376.71	\$ 346.57
Middle Spout:			
AXE28058	Wear Liner	\$ 147.56	\$ 135.76
AXE29779	Wear Liner (Dura Line™)	\$ 181.34	\$ 166.83
Flaps:			
AXE52630	Middle Flap	\$ 319.92	\$ 294.33
AXE55603	Middle Flap (Dura Line™)	\$1,279.70	\$1,177.32
AXE68374	End Flap	\$ 539.90	\$ 496.71
AXE68375	End Flap (Dura Line™)	\$2,159.62	\$1,986.85



Wear Liner Bottom

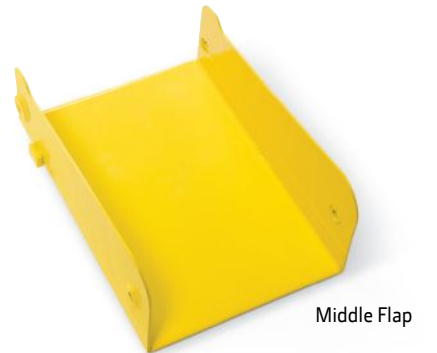

Middle Flap

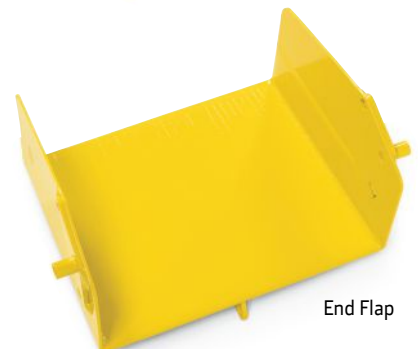

End Flap

Kernel Processor Rolls

The John Deere kernel processor is induction-hardened rather than flame-hardened, like many competitors' rolls. What does that mean to you? Hardening is much more consistent, resulting in a longer life and fewer repair costs. The hardening zones of a John Deere roll are shown in the illustration to the right.



Type	Standard	Saw Tooth Standard	Saw Tooth Chrome	Saw Tooth Whole Crop	Triangle Milo
Application	Standard Corn condition	Corn – provides higher aggressiveness	Corn – provides increased lifetime due to the hard chroming	All whole crop application	Alkalage and Milo
Gap Recommendation	2.5–3mm	2.5–3mm	2.5–3mm	0.5–1mm	0.5–1mm
Different Speed	21%	21%	21%	32%	32%

Kernel Processor Rolls

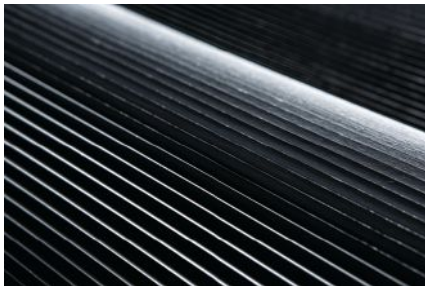

NUMBER	DESCRIPTION	APPLICATION	LIST	NOW
Standard Triangle:				
AZ101800	2 Needed	7200–7500, 7250–7550, 7180–7580	\$1,752.86	\$1,612.63
AZ102602	2 Needed	7700–7800, 7750–7950, 7780–7980	\$2,042.90	\$1,879.47
AXE43638	2 Needed	8100, 8200, 8300, 8400, 8500	\$1,904.53	\$1,752.17
AXE43491	2 Needed	8600, 8700, 8800	\$1,947.80	\$1,791.98
Saw Tooth Standard:				
AZ101800	2 Needed	7200–7500, 7250–7550, 7180–7580	\$1,752.86	\$1,612.63
AZ102602	2 Needed	7700–7800, 7750–7950, 7780–7980	\$2,042.90	\$1,879.47
AXE43571	Front Roll	8100, 8200, 8300, 8400, 8500	\$1,987.84	\$1,828.81
AXE43572	Rear Roll	8100, 8200, 8300, 8400, 8500	\$2,114.33	\$1,945.18
AXE43163	Front Roll	8600, 8700, 8800	\$2,303.27	\$2,119.01
AXE43182	Rear Roll	8600, 8700, 8800	\$2,303.27	\$2,119.01
Saw Tooth Chrome:				
AZ101376	2 Needed	7200–7500, 7250–7550, 7180–7580	\$2,486.64	\$2,287.71
AZ101377	2 Needed	7700–7800, 7750–7950, 7780–7980	\$2,910.82	\$2,677.95
AXE43640	Rear Roll	8100, 8200, 8300, 8400, 8500	\$3,044.64	\$2,801.07
AXE43492	Front Roll	8600, 8700, 8800	\$3,035.99	\$2,793.11
AXE43493	Rear Roll	8600, 8700, 8800	\$3,262.98	\$3,001.94
32% Saw Tooth Chrome (Rear Roll Reversed):				
AXE43492	2 Needed	8600, 8700, 8800	\$3,035.99	\$2,793.11
Saw Tooth Whole Crop:				
AZ102633	2 Needed	7200–7500, 7250–7550, 7180–7580	\$1,718.13	\$1,580.68
AXE43641	Front Roll	8100, 8200, 8300, 8400, 8500	\$1,893.70	\$1,742.20
AXE43642	Rear Roll	8100, 8200, 8300, 8400, 8500	\$1,857.65	\$1,709.04
AXE43494	Front Roll	8600, 8700, 8800	\$2,335.99	\$2,149.11
AXE43495	Rear Roll	8600, 8700, 8800	\$2,335.99	\$2,149.11
Triangle Milo / Sorghum:				
AZ54513	2 Needed	7200–7500, 7250–7550, 7180–7580	\$1,647.52	\$1,515.72
AXE43643	2 Needed	8100, 8200, 8300, 8400, 8500	\$1,857.65	\$1,709.04
AXE43496	2 Needed	8600, 8700, 8800	\$1,966.92	\$1,809.57

TAKE A LOAD OFF



JOHN DEERE



Watch a video on
Net Lift Assist



Visit Shop.Deere.com
and order yours today.

Elevate your net wrap loading experience with the new Net Lift Assist and Net Lighting from John Deere. Increase field safety and efficiency by adding this attachment to your John Deere round baler. Our bolt-on design streamlines the installation and is compatible with 7-, 8-, 9-, and 0-Series Round Balers. Upgrade today for the ultimate loading experience.

Round Baler Net Lift Assist & Net Lighting

Introducing the NEW John Deere Net Lift Assist — the ultimate solution for effortlessly loading net wrap on your round baler day or night. — Reliable and Durable. No cutting is required. A true bolt-on solution.

NUMBER	DESCRIPTION	LIST	NOW
BE33116	Net Lift Assist for 7-, 8-, and 9-Series Round Balers	\$1,999.00	\$1,899.05
BE33117	Net Lift Assist for 0-Series Round Balers	\$1,999.00	\$1,899.05
BE33118	Net Lighting Kit	\$ 255.40	\$ 237.52



John Deere Netwrap and Twine

NEW John Deere Mega Roll® with TamaTec+®

The all NEW John Deere Mega Roll is available in both CoverEdge™ and Edge to Edge®, which lasts up to 46% longer than a traditional-sized roll. With a larger roll, you have less downtime, less time spent reloading the baler with net, and enough net on one roll for a BIG day of baling, more than 300 6' bales at 2 wraps of net on hay. Mega Roll® meets the maximum roll diameter for a John Deere Round Baler. Pair the new Mega Roll with a Net Lift Assist for even easier loading.



John Deere Edge to Edge® with TamaTec+®

With more footage per roll, now you can make 10–15% more bales with each roll of net—for more baler productivity and less downtime. The new net is lighter and easier to handle, and priced right to reduce your cost per bale. It continues to give the same great bale coverage over the entire width of the bale, protecting the crop as well as helping to maintain the bale's shape, making handling and storage much easier. Now that's delivering the trouble-free baling you have come to know and expect from John Deere Netwrap.



John Deere CoverEdge™ with TamaTec+®

John Deere CoverEdge goes right over the edge of the bale and snaps into place for better protection. With the elimination of shoulders, bales are perfectly shaped for better handling, transport, and storage. John Deere CoverEdge covers 15% more surface area of the round bale and protects the edges of the bale to help prevent rainwater penetration and moisture collection within the bale. It also improves the weatherability of the package. No loose “fluff” to pick up the moisture from rainfall. With John Deere CoverEdge, you can produce high-quality silage bales when wrapped with stretch film because the bale surface is smooth, eliminating air pockets in the bale.



John Deere XtraTwine™ Plus

Large Square Bales

Reduces your cost and increases your baler's potential! Exclusively available through John Deere dealers.

Features include:

- Uniform spool shape and consistent yarn to ensure trouble-free running in the baler
- Guaranteed length
- Unrivaled knotting performance
- Special UV light inhibitors to withstand intense exposure over long periods
- Unique color combination for bale identification
- Compatible with ALL large square balers

Extra spool length

Extra spool length for less spool changes, less waste, and higher efficiency.



John Deere Round Baler Belts

John Deere offers two options for baler belts: **DiamondTough™** and **DiamondTough™ PRO**

Did you know that not all baler belts are created equal? DiamondTough™ 1-ply baler belts are made with advanced technology and materials, designed to withstand the rigors of hay production in any crop or field condition. Our belts have a superior 1-ply design that eliminates the risk of delamination caused by multiple rubber layers. Unlike our competitors' multi-ply design, we offer a larger single channel for our patented triple-weave technology. The three-step diamond tread design provides both built-in wear indicators and self-cleaning characteristics. As the diamond tread moves over the rollers, it stretches the concave, which releases the dirt and debris that could be trapped inside.



DiamondTough™ Baler Belts

John Deere's industry-leading DiamondTough baler belts feature:

- 1) Nylon-fill cords that provide superior puncture and tear resistance, along with excellent fastener-holding strength.
- 2) Excellent resistance to punctures and tears by inserting heavy-duty polyester straight-warp cords between the fill cords.
- 3) Polyester surface warp cords that resist abuse and increase flexibility over small baler rollers.
- 4) Nylon binder warp cords that help promote fabric integrity and abuse-resistant properties.

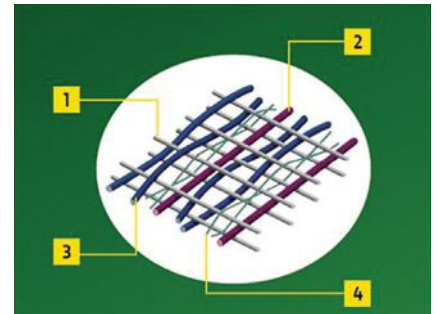

NUMBER	DESCRIPTION	APPLICATION	LIST	LIST
AFH215157	DiamondTough™ Short	330, 335, 375, 446, 546, 447, 448, 449, 440E, and 547	\$286.54	\$277.94
AFH215159	DiamondTough™ Long	330, 335, 375, 446, 546, 447, 448, 449, 440E, and 547	\$292.96	\$284.17
AE74209	DiamondTough™ Short	385, 6-, 7-, 8-, 9-, and 0-Series 5-ft. Balers	\$453.06	\$439.47
AE74210	DiamondTough™ Long	385, 6-, 7-, 8-, 9-, and 0-Series 5-ft. Balers	\$454.60	\$440.96
AE74177	DiamondTough™ Short	435, 535, 6-, 7-, 8-, 9-, and 0-Series 6-ft. Balers	\$494.04	\$479.22
AE74178	DiamondTough™ Long	435, 535, 6-, 7-, 8-, 9-, and 0-Series 6-ft. Balers	\$495.37	\$480.51

DiamondTough™ PRO Baler Belts

Our DiamondTough PRO baler belts are more wear- and tear-resistant than many belts in the industry and are built with the following features:

- Built with a special rubber compound that offers excellent resistance to cutting, gouging, and abrasion — A step above standard DiamondTough, it's the same compound used in rugged conveyor belt applications.
- Provide better performance in harsh baling conditions.
- DiamondTough PRO belts are highly recommended in abrasive conditions, such as when baling corn stalks and peanut hay or when working in sandy soils.

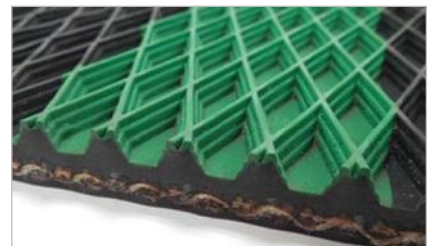

NUMBER	DESCRIPTION	APPLICATION	LIST	LIST
AFH212598	DiamondTough™ PRO Short	7-, 8-, 9-, and 0-Series 5-ft. Balers	\$553.61	\$537.00
AFH212599	DiamondTough™ PRO Long	7-, 8-, 9-, and 0-Series 5-ft. Balers	\$561.40	\$544.56
AFH210848	DiamondTough™ PRO Short	7-, 8-, 9-, and 0-Series 6-ft. Balers	\$619.52	\$600.93
AFH210849	DiamondTough™ PRO Long	7-, 8-, 9-, and 0-Series 6-ft. Balers	\$627.70	\$608.87

Net Guide

Net Guides are a great addition for any round baler 6-Series or newer. Net Guides bridge the gap between #10 and #12 rollers, to prevent the net from taking a detour and wrapping around the #11 roller. John Deere recommends installing 3 net guides (gap 2, 4, 6) on a 5-ft. wide round baler or 2 net guides (gap 2, 4) on a 4-ft. wide round baler. Each Net Guide requires 2 chain links which are ordered separately (Part #AH223103).

NUMBER	DESCRIPTION	LIST
FH345025	Net Guide	\$13.25
AFH223103	Chain Link	\$ 1.84



GREEN-GARD™ Hay Preservative

John Deere GREEN-GARD Hay Preservative is a buffered, propionic acid preservative that helps retain the freshness, color, and quality of the hay by stopping mold growth, heating, and spoilage.

- Bale when you're ready at moisture up to 30%
- Non-corrosive buffered formula won't harm expensive baling equipment, the user, or livestock
- Treated hay is greener, higher in feed value, and can be stored for years while looking and feeding as well as when it was baled

Ask your dealer about which hay preservative system is right for you!



Watch a video on
GREEN-GARD™

NUMBER	DESCRIPTION	Size	LIST
AFH216669	Mini Drum	13-gal. / 120-lbs.	\$ 232.00
AFH216670	Drum	50-gal. / 450-lbs.	\$ 687.00
AFH216672	Tote	200-gal. / 1,800-lbs.	\$2,728.00
AFH216673	Large Tote	270-gal. / 2,380-lbs.	\$3,432.00



Filter Maintenance

W235 Final Tier (FT4) Windrower



Scan to access additional Quick Reference Guides

CAB

Fresh Air Filter
RE284091
 Clean every 50 hours and replace as required.



CAB

Recirculation Air Filter
L214634
 Clean every 250 hours or each season, whichever occurs first, and replace as required.



ENGINE

Diesel Exhaust Fluid (DEF) Dosing Unit Filter
DZ114640
 Replace every 4,500 hours or three years of operation, whichever occurs first.



ENGINE

Open Crankcase Ventilation (OCV) Filter
DZ105796 (-018129)
DZ105100 (018130-)
 Replace every 1,500 hours.



ENGINE

Primary Air Filter
AN403918
Secondary Air Filter
AN403919
 Replace each season and as required.

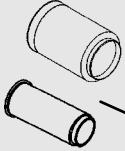

ENGINE

Fuel Tank Vent Filter
H216169
 Clean every 500 hours or each season, whichever occurs first.



HYDRAULIC
Reservoir Vent Filter
AT101565

Replace every 400 hours or each season, whichever occurs first.



HYDRAULIC
Return Filter (Draper)
AT318160

Replace every 400 hours or each season, whichever occurs first.



HYDRAULIC
Charge Filter
AH128449 (-420000)
T175002 (420001-)

Replace every 400 hours or each season, whichever occurs first.



ENGINE
Diesel Exhaust Fluid (DEF) Tank Vent Filter
H216169

Clean every 500 hours or each season, whichever occurs first.



ENGINE
Oil Filter
RE539279

Initial oil and filter change is after 100 hours of operation, then replace every 250 hours or each season, whichever occurs first.



ENGINE

Fuel Filter Kit (Includes Primary and Secondary)
RE556406 (Engine Option Code 35D5)
Primary Fuel Filter
DZ128543 (Engine Option Code 35JL, 35K3)
Secondary Fuel Filter
DZ115392 (Engine Option Code 35JL, 35K3)
 Replace every 500 hours or each season, whichever occurs first.

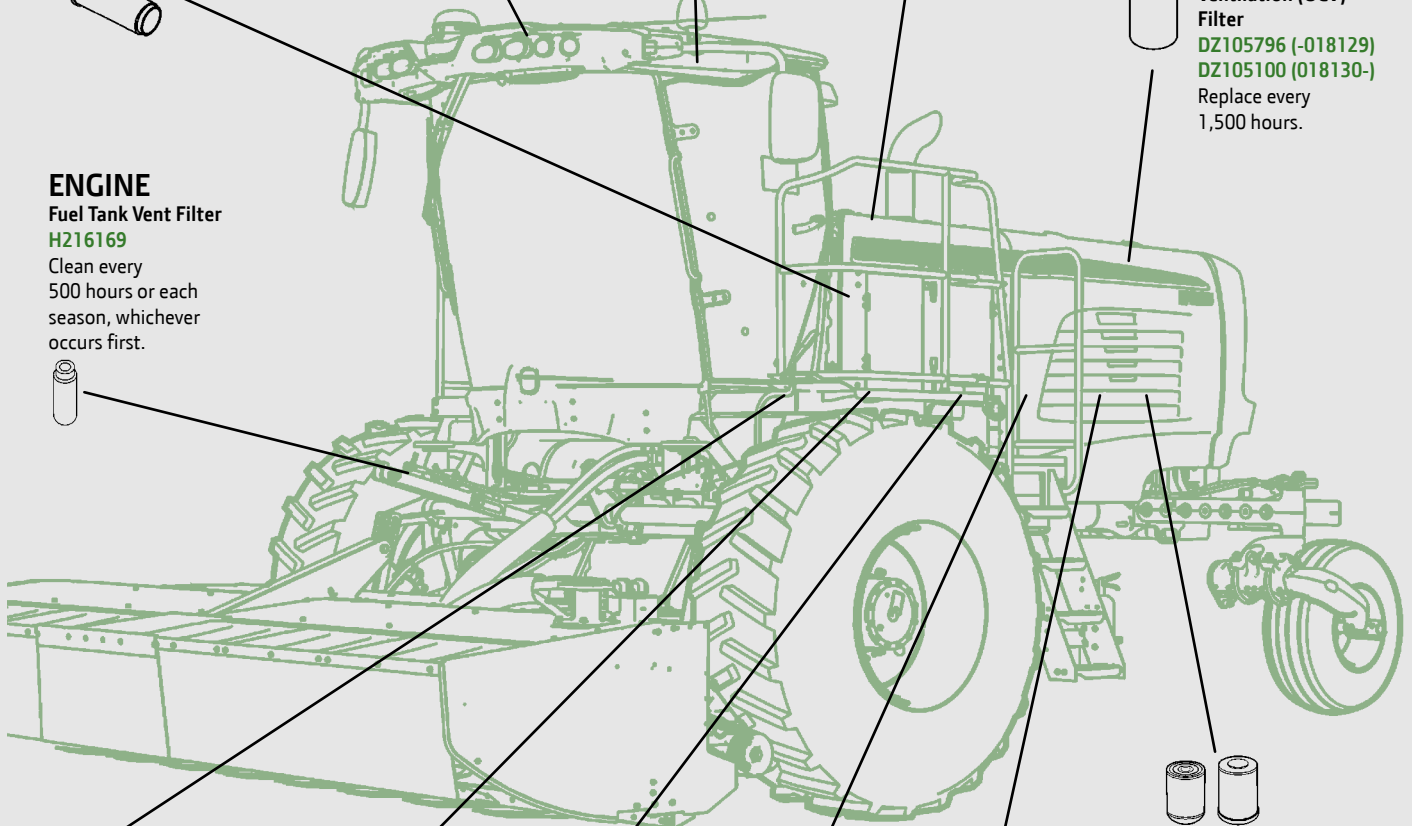



Advanced Hay, Straw, and Silage Tester

This newly advanced Hay, Straw, and Silage Tester is the most efficient probe on the market. The 20" stainless steel probe and tip provides accuracy, versatility, and durability. The SW007305 will measure push force to determine whether it's a high- or low-density bale, then adjusts the moisture result for more precise accuracy.

Features:

- Measures 8–72% moisture content
- Temperature range 32–185°F (0–85°C)
- Automatic Density Compensation
- Choice of hay or straw bales, separate mode for silage
- Memory can store results up to 64 bales with a total of 1,000 savable moisture and temperature readings
- Continuous reading as you probe bale

NUMBER	DESCRIPTION	LIST	NOW
SW007305	Hay, Straw, and Silage Tester	\$376.37	\$353.79



Hay Probes and Baler Mounted Testers

NUMBER	DESCRIPTION	LIST	NOW
--------	-------------	------	-----

Handheld Moisture Testers:

Moisture Testers:

SW16136	18-in. Probe (testing range from 14–44%)	\$222.63	\$209.27
SW16326	32-in. Probe (testing range from 14–44%)	\$248.12	\$233.23

Low-Moisture:

SW007320	20-in. Probe (testing range from 8–44%)	\$271.12	\$254.85
SW007321	10-in. Probe (testing range from 8–44%)	\$254.41	\$239.15

Baler-Mounted Hay Testers:

SW07350	Tester mounts inside the baler for direct readout of moisture while baling. (testing range from 8–44%)	\$348.04	\$327.16
SW007360	Advanced Baler-Mounted Hay Moisture Tester (BHT-2)	\$481.73	\$452.83

NEW Handheld Grain Protein and Moisture Tester

John Deere’s grain protein and moisture tester uses a lab-grade analyzer to combine portability with accuracy and ease of use before you even leave the field. It enables grain analysis by moving decision out of the lab, grain elevator, processing plants and feed mills. This tester uses Near Infra-Red Spectroscopy (NIRS) technology to determine protein, moisture, and oil.

Measures a variety of grains and forage for protein, moisture, and oil.

Operating temperature: 40°F–125°F (5°C–50°C)

Cup unit dimensions: H: 7-in., D: 6-in. (H: 179mm, D: 152mm)

Tests more than 2,000 samples on one full charge

Offline mode enables testing; results available when back online (cellular service)

Subscription required – not included with the price of the handheld tester



NUMBER	DESCRIPTION	LIST	NOW
--------	-------------	------	-----

SW008300	Handheld Grain Protein and Moisture Tester	\$2,268.78	\$2,132.65
----------	--	------------	-------------------

LaserRip™ II Ripper Points



Wingless LaserRip II

Part Number: KK28539

Application: Deere

Fits: 1 ¼-in. Parabolic Standard

LIST \$150.49
NOW **\$138.45**



5" LaserRip II

Part Number: KK28540

Application: Deere

Fits: 1 ¼-in. Parabolic Standard

LIST \$143.33
NOW **\$131.86**



7" LaserRip II

Part Number: KK28541

Application: Deere

Fits: 1 ¼-in. Parabolic Standard

LIST \$169.77
NOW **\$156.19**



10" LaserRip II

Part Number: KK28542

Application: Deere

Fits: 1 ¼-in. Parabolic Standard

LIST \$224.04
NOW **\$206.12**

LaserRip™ Ripper Points



2 ¾" LaserRip

Part Number: N237223

Application: Sunflower

Fits: 1 ¼-in. Parabolic Standard

LIST \$104.56
NOW **\$ 96.20**

Part Number: N236412

Application: DMI

Fits: 1 ½-in. Parabolic Standard

LIST \$115.01
NOW **\$105.81**



7" LaserRip

Part Number: N237224

Application: Sunflower

Fits: 1 ¼-in. Parabolic Standard

LIST \$128.05
NOW **\$117.81**

Part Number: N400739

Applications: DMI

Fits: 1 ½-in. Parabolic Standard

LIST \$159.92
NOW **\$147.13**



10" LaserRip

Part Number: N400740

Applications: DMI

Fits: 1 ½-in. Parabolic Standard

LIST \$192.16
NOW **\$176.79**

LaserRip™ Classic Ripper Points

The John Deere LaserRip™ Classic is a low disturbance ripper point, ideal for operators who want to create less soil disturbance and a more even soil profile at shallower depths. The LaserRip Classic has improved thickness and reinforced in key critical wear areas of the sweep compared to the previous version of the low disturbance ripper point.

NUMBER	DESCRIPTION	LIST	NOW
KK47198	7" LaserRip™ Classic	\$148.09	\$136.24
KK47199	10" LaserRip™ Classic	\$191.65	\$176.32





John Deere Diamond Series Disk Blades

- Made of reliable, long-lasting steel for high-performance disking
- Precision-sharp edges for proper residue cutting and sizing
- Made in the U.S.A.

NUMBER	DESCRIPTION	APPLICATION	LIST	NOW
Spherical, Plain Edge:				
N186718	16-in x 0.177, 1.05 x 1.17 Dual Square	630, 635, 637, 2620, 2623, 2625, 2630, 2633, 2635, 2623VT, 2633VT	\$ 45.48	\$ 41.84
B31315	18-in. x 0.138, 1 1/8 x 1 1/4-in. Dual Square	115, 215, 235, 315, 335, 355, 375, 455, 627, 630, 637	\$ 61.51	\$ 56.59
A47239	18-in. x 0.197, 1 1/8 x 1 1/4-in. Dual Square	215, 235, 2620, 2623, 2625, 2623VT, 2720, 2330, 2630, 2633, 2635, 2633VT, 512, 630, 637, 640, 722, 724, 726	\$ 66.93	\$ 61.58
B31318	20-in. x 0.177, 1 1/8 x 1 1/4-in. Dual Square (2.03-in. concavity)	115, 215, 235, 315, 335, 355, 455, 2620, 2623, 2625, 2623VT, 2630, 2633, 2635, 2633VT, 2730, 710, 630, 637, 640, 650	\$ 78.45	\$ 72.17
N231991	20-in. x 0.177, 1 1/8 x 1 1/4-in. Dual Square (1.63-in. concavity)	512, 637, 650, 726	\$ 77.44	\$ 71.24
N330738	20-in. x 0.197, 1 1/8 x 1 1/4-in. Dual Square	2310, 2330	\$ 82.20	\$ 75.62
A49254	22-in. x 0.177, 1 1/8 x 1 1/4-in. Dual Square	115, 215, 235, 315, 335, 355, 630, 637, 640	\$ 94.99	\$ 87.39
N242916	22-in. x 0.197, 2-in. Round	2620, 2623, 2625, 2630, 2633, 2635, 2623VT, 2633VT	\$ 92.17	\$ 84.80
A35487	22-in. x 0.256, 1 1/8 x 1 1/4-in. Dual Square	215, 235, 315, 331, 335, 350, 355, 712, 630, 637, 640, 650, 2700	\$118.24	\$108.78
A42170	22-in. x 0.256, 1 1/2-in. Round	215, 235	\$ 74.13	\$ 68.20
N242216	22-in. x 0.256, 1 1/8 x 1 1/4-in. Dual Square	512, 650, 2700	\$113.16	\$104.11
N240064	24-in. x 0.177, 1 1/8 x 1 1/4-in. Dual Square	630, 640, 650	\$123.20	\$113.34
N241278	24-in. x 0.197, 1 1/8 x 1 1/4-in. Dual Square	635, 637	\$126.03	\$115.95
B35606	24-in. x 0.256, 1 1/8 x 1 1/4-in. Dual Square	300 Series, 510, 637, 640, 650	\$120.43	\$110.80
N242322	24-in. x 0.256, 1 1/8 x 1 1/4-in. Dual Square	512, 635, 637, 650	\$132.95	\$122.31
N242921	24-in. x .256, 2-in. Round (2.8-in. Concavity)	2620, 2623, 2625, 2630, 2633, 2635	\$131.31	\$120.81
N242998	24-in. x 0.256, 2-in. Round (2.3-in. Concavity)	2620, 2623, 2625, 2630, 2633, 2635 Disk, 2720, 2730 Rippers	\$121.89	\$112.14
N242923	26-in. x 0.256, 2-in. Round	2620, 2623, 2625, 2630, 2633, 2635	\$165.60	\$152.35
B35608	26-in. x 0.256, 1 1/4-in. Square	300 Series, 640, 650	\$168.28	\$154.82
Conical, Plain Edge:				
A28610	22-in. x 0.256, 1 1/8 x 1 1/4-in. Dual Square	215, 235, 300 series, 630, 640, 650, 670	\$123.48	\$113.60
B32715	24-in. x 0.256, 1 1/4-in. Square	300 Series, 640, 650, 670	\$157.41	\$144.82
B28211	24-in. x 0.256, 1 1/2-in. Square	1630, 1635, 1640 Disks, 225, 425 Offset Disks	\$160.20	\$147.38

Conventional Chisel Plow Sweeps

Both low- and medium-crown wing designs provide excellent soil mixing and residue retention.



NUMBER	SIZE	CROWN	STYLE	LIST	NOW
N130188	6 1/2-in.	Medium	Medium	\$22.44	\$20.64
47CP014	14-in.	Medium	Medium	\$32.41	\$29.82
N130182	14-in.	Medium	Medium	\$27.57	\$25.36
47CP016	16-in.	Medium	Medium	\$34.01	\$31.29
N130177	16-in.	Low	Narrow	\$30.20	\$27.78
N130183	16-in.	Medium	Medium	\$29.93	\$27.54
N130184	18-in.	Medium	Medium	\$36.12	\$33.23
N130185	20-in.	Medium	Medium	\$45.73	\$42.07

Tru-Width™ Chisel Plow Sweeps

The unique wing design of Tru-Width sweeps ensures that they maintain their original cutting width and a sharp point. These sweeps fit John Deere and most brands of chisel plows, mulch tillers, and air seeders.



NUMBER	SIZE	SHANK ANGLE	LIST	NOW
Medium-Crown Sweeps:				
N182044	8-in. Regular Wing	51 Deg.	\$23.93	\$22.02
N182045	10-in. Regular Wing	51 Deg.	\$23.57	\$21.68
N182046	12-in. Regular Wing	51 Deg.	\$26.89	\$24.74
N182035	12-in. Wide Wing	51 Deg.	\$24.97	\$22.97
N182036	14-in. Wide Wing	51 Deg.	\$31.80	\$29.26
N182037	16-in. Wide Wing	51 Deg.	\$32.27	\$29.69
N182038	18-in. Wide Wing	51 Deg.	\$39.92	\$36.73

Chisel Points

High-carbon steel for long life and superior performance. Retains original shape and stays sharp, even after considerable use.



NUMBER	SIZE	THICKNESS	LIST	NOW
Chisel Points for Heel Sweeps, Double Point:				
N130190	2-in. x 16-in.	5/8-in.	\$18.84	\$16.58
N130193	4-in. x 14 1/2-in.	3/8-in.	\$23.19	\$21.33
Single-Point Chrome Cap:				
N237890	2-in. x 12-in.	7/8-in.	\$42.87	\$39.44
AN231796	2-in. x 12-in.	7/8-in.	\$39.87	\$36.68
Heavy-Duty Double Point:				
N237910	2-in. x 16-in.	7/8-in.	\$33.67	\$30.98

Concave Twisted Double-Point Shovels

- Create “soil ribbons” on field surface using crop residue to minimize soil erosion
- Produces excellent soil/trash mixing to help break down residue



NUMBER	SIZE	LIST	NOW
1/2-in. Material Thickness:			
N181912	1/2-in. x 3-in. x 24-in., Right-hand	\$34.71	\$31.93
N181913	1/2-in. x 3-in. x 24-in., Left-hand	\$34.71	\$31.93
N181906	1/2-in. x 4-in. x 24-in., Right-hand	\$44.39	\$40.84
N181907	1/2-in. x 4-in. x 24-in., Left-hand	\$44.39	\$40.84

Twisted Slash Points

- Designed to fit most minimum-till coulters on the market today
- Made from 1/2-in. x 4-in. 1080 high-carbon steel for long life and superior performance
- Also available with hard-faced cutting edge for extended life



NUMBER	SIZE	LIST	NOW
N237720	1/2-in. x 4-in. x 26-in., Right-hand	\$50.99	\$46.91
N237721	1/2-in. x 4-in. x 26-in., Left-hand	\$50.99	\$46.91
N237722	1/2-in. x 4-in. x 26-in., Hard-faced, Right-hand	\$85.63	\$78.78
N237723	1/2-in. x 4-in. x 26-in., Hard-faced, Left-hand	\$84.75	\$77.97

Min-Till Ripper Points



- Wingless points provide ultra-low surface-soil disturbance
- Choose 7-in. points for moderate soil disturbance
- 10-in. points deliver low surface-soil disturbance
- Fits John Deere 913 and 915 Rippers and 2100 Min-Till Ripper

NUMBER	WING WIDTH	LIST	NOW
John Deere LaserRip™ Min-till 3/4-in. Straight Standard (ultra-low-to-moderate soil disturbance):			
N262903	Wingless	\$155.27	\$142.85
N262740	7-in.	\$172.12	\$158.35
N262902	10-in.	\$152.61	\$140.40

Moldboards for John Deere



- High-carbon steel construction is perfect for abrasive or rocky soil
- Fits precisely with shins and other components to maintain proper soil flow

NUMBER	DESCRIPTION	LIST	NOW
NU Bottom:			
A15596	16-in., Right-hand	\$313.92	\$288.81
A17432	18-in., Left-hand	\$279.42	\$257.07
Metric Bottom:			
A32209	450 mm, Right-hand	\$333.79	\$307.09
A32210	400 mm, Right-hand	\$588.27	\$541.21
HS Bottom:			
A20700	14-in., Right-hand	\$189.19	\$174.05
A20702	16-in., Right-hand	\$203.46	\$187.18

Plowshares for John Deere



- High-carbon, heat-tempered construction delivers long life in tough conditions
- Choose from several designs to fit the way you till

NUMBER	DESCRIPTION	LIST	NOW
NU Bottom:			
A51499	14-in., Share, Narrow-cut, Right-hand	\$ 56.54	\$ 52.02
A51500	16-in., Share, Full-cut, Right-hand	\$ 40.86	\$ 37.59
A51501	16-in., Share, Narrow-cut, Right-hand	\$ 29.56	\$ 27.20
A51503	16-in., Share, Full-cut, Left-hand	\$ 27.99	\$ 25.75
A51504	18-in., Share, Full-cut, Right-hand	\$ 43.45	\$ 39.97
A51506	18-in., Share, Full-cut, Left-hand	\$ 30.78	\$ 28.32
Metric Bottom:			
A42805	350 mm, Heavy-duty, Share, Right-hand	\$ 52.31	\$ 48.13
Hard-Faced:			
A42946	400 mm, Hard-faced, Share, Full-cut, Right-hand	\$141.07	\$129.78
A42947	450 mm, Hard-faced, Share, Full-cut, Right-hand	\$ 99.04	\$ 91.12
A51508	16-in., Hard-faced, Share, Full-cut, Right-hand	\$100.24	\$ 92.22
A51509	16-in., Hard-faced, Share, Full-cut, Left-hand	\$143.53	\$132.05
A51510	18-in., Hard-faced, Share, Full-cut, Right-hand	\$112.75	\$103.73
Reversible Point:			
A45243	Share for Reversible Point	\$189.45	\$174.29
A45244	Share for Reversible Point	\$ 46.74	\$ 43.00
Hard Faced Gumbo-extended Point:			
A44851	450 mm, Hard-faced, Share, Gumbo	\$230.34	\$211.91

NEW SOLUTIONS

FOR SEEDING FROM A&I PRODUCTS



A-DBSFTKIT

Double Agitator Kit

- *Stainless Steel construction*
- *The Air Seeder Parts Double Agitator reduces the bridging of product and keeps flow moving at a continuous rate through the transition from the tank to meter*

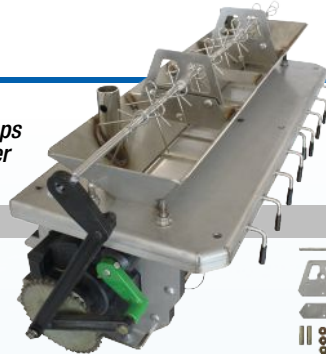

FITS John Deere AIR SEEDER CART: 1900, 1910, C650, C850

Top image shows A-DBSFTKIT installed on a meter and transition assembly. The kit is shown in the inset image to the right.



A-DSHOOTKT

Double Shoot Manifold Kit

- *Stainless Steel construction*
- *Universal to fit all run configurations*
- *One-piece, bolt-on design*
- *Replaces original plastic design*
- *Includes stainless steel clamps, gasket, & hardware*



FITS John Deere AIR SEEDER CART: 1900, 1910

A-SEEDTBL | A-SEEDTBR | A-SEEDTBS

Seed Tube w/Clamp - LH, RH, & Straight

- *Stainless Steel construction*
- *Hose barbs are eliminated. Each tube features a cut-out window wide enough for the stainless hose clamp to grip the hose, securing it inside the tube.*
- *Requires only a screwdriver to disconnect and reconnect hose*
- *Includes stainless steel clamp*

Replaces John Deere: A81407 (LH), A81406 (RH), A72825 (Straight)

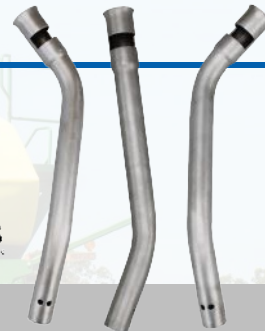

FITS John Deere GRAIN DRILL: N530, N530C, N530F, N536, N536C, N540, N540C, N540F, N542, N542C, N543F, N550, N560, N560F, 1690, 1890, 1895, 1990

A-TRUMTR | A-TRUMTR1 | A-TRUMTR2 | A-TRUMTR3

TRU-Metering Insert

- *Reduces the space between the meter roller and the insert inside the meter cartridge, only allowing the product within the flutes to meter through the cartridge*
- *Eliminates product siphoning, especially with small seeds and fine products.*
- *Available in solid (A-TRUMTR) and grooved for tuning ring clearance: 1 groove (A-TRUMTR1), 2 groove (A-TRUMTR2), 3 groove (A-TRUMTR3)*

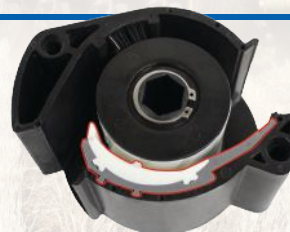

FITS John Deere AIR SEEDER CART: 1900, 1910, C650, C850

Top image shows TRU-Metering Insert installed in cartridge. Inserts shown to the right.



SEE YOUR DEALER FOR MORE INFORMATION ON THESE NEW SEEDING PRODUCTS FROM A&I

ProSeries™ Seed Opener Performance Upgrade Kits for 60- and 90-Series Openers

The ProSeries™ Opener offers agronomic advantages and extended wear life compared to the current 90-Series openers. For 60-Series openers, to be compatible, seed tubes must also be upgraded to the 90-Series seed tubes.

Features include:

Seed Boot – A narrower, tighter fit to the disk results in less soil throw for better seed-to-soil contact and extended wear life.

Press Wheel – Narrower and more flexible press wheel improves overall seed-to-soil contact for more even emergence, plus upgraded double-row ball bearing extends service life.

Serrated Closing Wheel – Improved closing system when seeding in harder, drier conditions. The notches on the wheel break up the drier soil for better germination.

Seed Tab – Improved material for longer wear life, angled and more flexibility in the seed trench results in less seed bounce for more consistent seed placement.

Closing Spring – Easier adjustments.



NUMBER	DESCRIPTION	APPLICATION	LIST	NOW
AA97392	Seed Opener Performance Upgrade Kit	8-Rows (4 right/4 left)	\$2,154.60	\$1,982.23
AA98693	Seed Opener Performance Upgrade Kit	2-Rows (1 right/1 left)	\$ 567.00	\$ 521.64

Upgrade your 90-Series Openers with ProSeries™ Parts

ORIGINAL 90-SERIES PART NUMBER	PROSERIES PART NUMBER	DESCRIPTION	PROSERIES LIST	PROSERIES NOW
N282110	A105392	Serrated Closing Wheel	\$106.57	\$ 98.04
N219982	A105410	Seed Tab	\$ 4.14	\$ 3.81
N284025	A109344	Seed Boot, RH	\$157.88	\$145.25
N284024	A109343	Seed Boot, LH	\$157.88	\$145.25
AN282296	AA88056	Press Wheel	\$ 66.88	\$ 61.53
N283804	N283804 (did not change)	Disk Blade	\$ 49.72	\$ 45.74
N284024	A109343	Seed Boot, LH	\$157.88	\$145.25
A118430	A110308	Closing Spring, RH	\$ 16.08	\$ 14.79
A118429	A110307	Closing Spring, LH	\$ 16.08	\$ 14.79

Separate Fertilizer Placement Openers for 90-Series

Features include:

Separate Fertilizer Placement (SFP) sealing wing allows for better sealing of NH3 in the ground. Newly designed sealing plates and scrapers improve the NH3 sealing capabilities of the SFP opener when compared with older components. 457.2mm (18-in.) opener blades operate at a 5-degree angle, resulting in a narrow trench with less soil disturbance.

Kit contents include: Scraper, Sealing Plate, Disk Opener, Hardware, (smooth or serrated closing wheel is not included).

NUMBER	DESCRIPTION	APPLICATION	LIST	NOW
AA102151	SFP Opener Performance Upgrade Kit	8-Rows (4 right/4 left)	\$2,005.88	\$1,845.41
AA102150	SFP Opener Performance Upgrade Kit	2-Rows (1 right/1 left)	\$ 632.89	\$ 582.26



No-Till Opener Kits – Continuing to provide solutions for the life of your machine

New parts & kits available through parts:

- Depth Adjust Kit
- Main Opener Pivot Pin & Bushing Kit
- Quick Change Blade Kit
- Heavy-Duty Gauge Wheel Tire – Narrow
- Heavy-Duty Spoked Gauge Wheel Assembly – Narrow
- Greaseless Bushing Kit – 90-Series

Depth Adjust Kit

- Solves issues with wear on the cover and/or handle
- ProSeries™ components offer added strength and durability
- New kit contains handle, cover and all necessary hardware for one row
- Allows 90-Series customers to easily upgrade to ProSeries components



NUMBER	DESCRIPTION	LIST	NOW
AA110766	Depth Adjust Kit	\$49.72	\$45.74

Main Opener Pivot Pin & Bushing Kit

- Convenience kit that contains pin, bushings and all necessary hardware to service one row
- Lower price compared to ordering individual parts

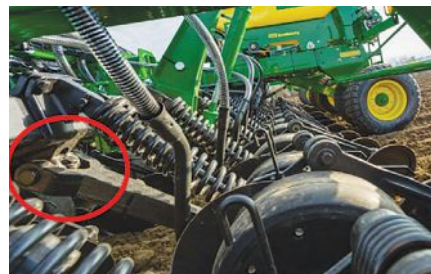

NUMBER	DESCRIPTION	LIST	NOW
AA110767	Main Opener Pivot Pin & Bushing Kit	\$60.66	\$55.81





Quick Change Blade Kit

- Reduces maintenance time for blade change
- Improvement made to ProSeries™ openers in Model Year 2022 – allows for faster blade changes, reducing planned downtime
- Kit allows customers of 90-Series and pre-MY22 ProSeries openers to upgrade to the quick change blade feature

NUMBER	DESCRIPTION	LIST	NOW
AA110550	4-Rows (2 left and 2 right)	\$ 800.00	\$ 736.00
AA110551	16-Rows (8 left and 8 right)	\$2,880.00	\$2,649.60

NOTE: Must also upgrade to ProSeries™ seed boots.



Heavy-Duty Gauge Wheel Tire – Narrow

- Similar to heavy-duty standard width gauge wheel tire A113507, but with a narrow profile
- Thicker material in the lip area
- Provides longer wear life of gauge wheels, especially in high residue conditions
- Helps ensure gauge wheel performance for consistent seed placement and depth
- Drop-in replacement for A85133 narrow tire

NUMBER	DESCRIPTION	LIST	NOW
A134844	Heavy-Duty Gauge Wheel Tire – Narrow	\$68.54	\$63.06



Heavy-Duty Spoked Gauge Wheel Assembly – Narrow

- Helps ensure gauge wheel performance for consistent seed placement and depth
- Spoked gauge wheel assembly in narrow profile – similar to AA98188
- Spokes allow for increased material flow through the openers
- Contains heavy-duty tire (A134844) and heavy-duty bearing (AA97285) for increased durability and service life
- Provides longer wear life of gauge wheels, especially in high residue conditions

NUMBER	DESCRIPTION	LIST	NOW
AA110983	Heavy-Duty Spoked Gauge Wheel Assembly – Narrow	\$228.81	\$210.51



Greaseless Bushing Kit – 90-Series

- Eliminates daily grease points of closing and press wheel pivots
- Increases uptime, by reducing planned maintenance
- Kits include all parts needed to retrofit **one** opener (closing wheel and press wheel pivots) to greaseless bushings

NUMBER	DESCRIPTION	LIST	NOW
AA110762	90-Series Closing/Press Wheel	\$128.96	\$118.64
AA110763	5-Degree SFP	\$137.99	\$126.95
AA110764	7-Degree SFP	\$137.99	\$126.95

Air Seeder Hose—Low Pressure

Good:

- Standard-Duty
- Application: Small to medium acreages with lighter fertilizer application

Better:

- Light Heavy-Duty – 2 to 2.5 times standard PVC
- Application: Medium to large acreages with fertilizer applications

Best:

- Heavy-Duty – 2.5 to 3 times standard PVC
- Application: Large acreages with fertilizer applications including potash



NUMBER	ID	OD	LIST	NOW
Good:				
PM112BK100	1.00-in. (25.4mm)	1.25-in. (31.8mm)	\$1.44	\$1.32
PM112GR100	1.00-in. (25.4mm)	1.25-in. (31.8mm)	\$1.36	\$1.25
PM112BK250	2.50-in. (63.5mm)	2.84-in. (72.1mm)	\$4.44	\$4.08
PM112GR250	2.50-in. (63.5mm)	2.84-in. (72.1mm)	\$4.39	\$4.04
Better:				
PM113UVBK100	1.00-in. (25.4mm)	1.25-in. (31.8mm)	\$2.60	\$2.39
PM113UVCLBK	2.50-in. (63.5mm)	2.84-in. (72.1mm)	\$6.77	\$6.23
Best:				
PM100ULBK100 PM100ULGR100	1.00-in. (25.4mm)	1.25-in. (31.8mm)	\$3.29	\$3.03
PM100UCLBK	2.50-in. (63.5mm)	2.87-in. (72.9mm)	\$7.71	\$7.09
PM100ULGR250	2.50-in. (63.5mm)	2.87-in. (72.9mm)	\$7.73	\$7.11

Price shown is per foot. BK = Clear w/ Black Helix, GR = Clear w/ Green Helix.
See dealer for other sizes and color combinations.

Meters, Rollers, and Tuning Rings for John Deere Air Seeders

Use the low meter roller for seeds such as flax, canola, and alfalfa. The medium roller is best when planting wheat, barley, canola, and small soybeans up to 1/4 inch in diameter and with medium rates of fertilizer. The high rate roller is for high rates of fertilizer and large soybeans bigger than 1/4 inch in diameter. The very high rate roller is best used when planting barley and oats with beards, large seeds such as garbanzo beans, and with very high fertilizer rates. Fine tuning rings reduce the amount of product available to meter for increased accuracy.

NUMBER	METER TYPE	APPLICATION RATE	LIST	NOW
Meter Roller Kits:				
AA45605	Low	1–20 lb. Per Acre	\$ 93.76	\$ 86.26
AA45606	Regular	20–130 lb. Per Acre	\$129.35	\$119.00
AA45607	High Rate	30–220 lb. Per Acre	\$117.26	\$107.88
Meter Rollers:				
A58874	Low	1–20 lb. Per Acre	\$ 84.05	\$ 77.33
A58473	Regular	20–130 lb. Per Acre	\$ 65.23	\$ 60.01
A58479	High Rate	30–220 lb. Per Acre	\$ 53.37	\$ 49.10
A69212	Very High Rate	50–265 lb. Per Acre	\$ 48.22	\$ 44.36
Fine-Tuning Rings:				
A57192	Low		\$ 10.03	\$ 9.23
A57197	Regular		\$ 9.46	\$ 8.70
A57195	High Rate		\$ 9.46	\$ 8.70
A70069	Very High Rate		\$ 11.06	\$ 10.18

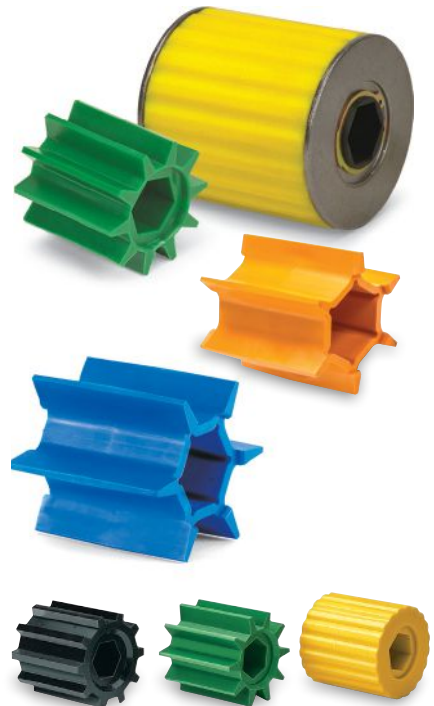



GET A HEADSTART

A QUALITY VALUE ALTERNATIVE FOR MAX EMERGE PLANTERS

A&I Products continues to expand the alternative selection when it comes to planter parts. Since the introduction of A&I planter parts in early 2022, the portfolio has grown to over 170% of the initial offering. Take, for example, these NEW coulters blades available in four styles.

A-A72361

Concave Notched Disc
16" Diameter
2.598" Bolt Circle

A-A72360

Coulters Blade, Bubbled
15.86" Diameter
4.75" Bolt Circle

A-A72678

Coulters Blade, 13 Wave
15.86" Diameter
4.75" Bolt Circle

A-A72680

Coulters Blade, 25 Wave
15.86" Diameter
4.75" Bolt Circle

When searching for the right planter parts at the right price, know your trusted local John Deere dealer can supply you with Genuine John Deere and A&I Products to meet your specific replacement parts need.





Hagie Sprayer Attachments

Looking to upgrade the performance of your Hagie Sprayer? The attachment kits listed below are available from John Deere, please see your local dealer for more information.



Rear Boom



Crop Dividers



Tall Crop Package



Modular Injection



Side Fill



Front Fill



Intake Scoop

NUMBER	DESCRIPTION	LIST	NOW
5HGAMK001	Rear Boom for STS, 15"	\$1,486.69	\$1,367.75
5HGAMK015	Tall Crop Option for STS 10/12, model years 2014 to 2016	\$4,503.76	\$4,143.46
5HGAMK047	Tall Crop Option for STS 10/12, model years 2017 to 2018	\$4,473.45	\$4,115.57
5HGAMK063	Tall Crop Option for DTS, model years 2016 to 2018	\$1,231.79	\$1,133.25
5HGAMK056	Front Fill Option for STS 10/12/14/16, model years 2014 to 2018	\$1,485.04	\$1,366.24
5HGAMK011	STS Crop Divider, model years 2015 to 2017	\$1,243.54	\$1,144.06
5HGAMK007	STS Crop Divider, STS 10/12/14/16, model years 2014 to 2015, Standard Leg	\$1,169.16	\$1,075.63
5HGAMK036	DTS Crop Divider, model years 2016 to 2018	\$ 952.51	\$ 876.31
5HGAMK105	Intake Scoop for STS 10/12/14, model year 2017 – STS 10/12, model year 2018	\$1,268.31	\$1,166.85
5HGAMK107	Intake Scoop for STS 16, model year 2017 – STS 14/16, model year 2017	\$1,253.45	\$1,153.17
5HGAMK053	Foamer Option for STS 10/12/14/16, model years 2016 to 2018	\$4,503.03	\$4,142.79
5HGAMK102	Night Spray Lights for STS 90/100' Boom, model years 2016 to 2018	\$ 407.37	\$ 374.78
5HGAMK104	Night Spray Lights for STS 120' Hybrid Boom, model years 2017 to 2018	\$ 387.96	\$ 356.92



Scan for information on Solution System Cleaning

Solution System Cleaning

Flowmeters are a critical part of the sprayer and require regular cleaning. Flowmeters that are not maintained and cleaned at regular intervals can give erratic readings, affecting the application rate.

To avoid damage to flowmeters and prevent possible chemical application rate issues:

- Flush the solution system daily as described in Operator’s Manual with clean water.
- Remove flowmeters as required and clean the turbine and bearing area with TY26101 John Deere Brake and Parts Cleaner.
- Properly clean and winterize solution system when preparing machine for storage. (See the Storage section of the Operator’s Manual for procedure.)

Watch our YouTube® video on Solution System Cleaning to learn more.

NUMBER	DESCRIPTION	APPLICATION	LIST	NOW
AN305056	Flowmeter Insert	4700, 4710, 4720, 4920, 4730, 4830, 4930, 4940 , R4023–R4060, 408R–412R, 612R–616R	\$461.64	\$424.71
AKK23982	Flowmeter Sensor	4700, 4710, 4720, 4920, 4730, 4830, 4930, 4940 , R4023–R4060, 408R–412R, 612R–616R	\$203.49	\$187.21
AN305055	Flowmeter Assembly (Housing , insert and sensor)	4700, 4710, 4720, 4920, 4730, 4830, 4930, 4940 , R4023–R4060, 408R–412R, 612R–616R	\$732.09	\$673.52

High-Flow Nozzle Body

Our 5-way nozzle body enables quick spray nozzle changeover. Simple rotate the nozzle body until the desired nozzle is in the spraying position.

- Designed to deliver the highest flow rates across the spraying pressure range
- Provides the lowest pressure drop at any given flow in the industry
- Reduces restrictions in the flow path through a unique DCV design
- Supports faster field speeds with the same coverage



NUMBER	DESCRIPTION	LIST	NOW
AN206621	5-Position High Flow, 1 ¹ / ₁₆ -in. Port, Viton® Seals	\$35.62	\$32.77
PMHF12DCV	12-psi Check Valve with Viton Diaphragm (16 Open/12 Close)	\$ 3.50	\$ 3.22
PMHF15DCV	15-psi Check Valve with Viton Diaphragm (22 Open/15 Close)	\$ 4.47	\$ 4.11

SC-2 Sprayer Calibrator

Automatically calculates and displays tip flow rate (in gpm, l/min, oz/min), tip wear (in percent), and application rate (in gpa, l/ha)

Fast and simple operation with readings in about 10 seconds per tip

Helps quickly identify worn spray nozzle tips

(recommend tip replacement once flow rate exceeds that of new tip by 10%)

Accurately measures true tip flow rate that is essential for calibrating today’s high-tech sprayers

Replaces discontinued SC-1 Sprayer Calibrator (PM23890)



NUMBER	DESCRIPTION	LIST	NOW
PM38790	SpotOn® Sprayer Calibrator Model SC-2 (up to 2.25 gpm)	\$179.00	\$164.68

ForceField Centrifugal Pump

Superior wet-seal protection for today's most demanding spray conditions.

- Wet-seal technology protects the seals by using a barrier fluid to keep them cool and lubricated, even while the pump is running dry
- Actively maintains a positive pressure differential between the chamber barrier fluid and the pumping solution, which prevents chemical bonding of the seal faces, resulting in increased life and maintenance-free operation
- Protects seal against dry run failure
- Minimizes sprayer downtime and improves productivity

Ask us how the Forcefield pump provides worry-free sprayer operation.

NUMBER	DESCRIPTION	APPLICATION	LIST	NOW
AKK30367	High-Flow Cast-Iron ForceField Pump	R4038, R4044, R4045, R4060, 410R, 412R, 612R, 616R	\$6,767.21	\$6,225.83
AKK30366	High Flow Cast Iron Forcefield Pump, less hydraulic motor	R4038, R4044, R4045, R4060, 410R, 412R, 612R, 616R	\$5,208.14	\$4,791.49
AKK39831	Standard Flow ForceField Pump	R4030 – R4060, 408R, 410R, 412R, 616R, 800R	\$2,979.22	\$2,740.88

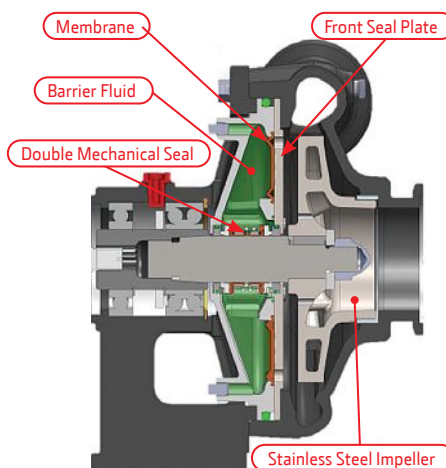

Sprayer Strainers

NUMBER	DESCRIPTION	LIST	NOW
PMLS350	50 Mesh Fill Strainer	\$138.40	\$127.33
PMLST1530	Boom Solution Strainer 30 Mesh – Poly	\$ 49.99	\$ 45.99
PMLST1550	Boom Solution Strainer 50 Mesh – Poly	\$ 49.99	\$ 45.99
PMLST1580	Boom Solution Strainer 80 Mesh – Poly	\$ 49.99	\$ 45.99
PMLST230SS	Boom Solution Strainer 30 Mesh – Steel	\$ 59.38	\$ 54.63
PMLST2100SS	Boom Solution Strainer 100 Mesh – Steel	\$ 59.38	\$ 54.63
N303557	Pressure Strainer 50 Mesh	\$121.23	\$111.53
N311241	Pressure Strainer 80 Mesh	\$ 84.59	\$ 77.82
PMLST150	Center Frame Solution Strainer – Poly	\$ 18.37	\$ 16.90



Banjo Valves

Your John Deere dealer offers an extensive line of Banjo valves and replacement parts. These high-quality valves are used on John Deere sprayers and many other farm applications.



NUMBER	DESCRIPTION	PIPE SIZE	OPENING THRU BALL	LIST	NOW
Polypropylene Bolted Ball Valves – 4 Bolt Valve:					
PMV075	Full Port – 150 PSI Max.	3/4"	3/4"	\$ 38.79	\$ 35.69
PMV100	Standard Port – 150 PSI Max.	1"	3/4"	\$ 38.79	\$ 35.69
PMV100FP	Full Port – 150 PSI Max.	1"	1"	\$ 42.84	\$ 39.41
PMV125	Standard Port – 150 PSI Max.	1 1/4"	1"	\$ 44.96	\$ 41.36
PMV150	Full Port – 150 PSI Max.	1 1/2"	1 1/2"	\$ 54.88	\$ 50.49
PMV200	Standard Port – 150 PSI Max.	2"	1 1/2"	\$ 57.78	\$ 53.16
Polypropylene Bolted Ball Valves – 6 Bolt Valve:					
PMV200FP	Full Port – 150 PSI Max.	2"	2"	\$ 81.38	\$ 74.87
PMV300FP	Full Port – 100 PSI Max.	3"	3"	\$191.28	\$175.98
Polypropylene Manifold Bolted Ball Valves – 150 PSI Max.:					
PMMV100CF	1" x 1" Flange Ball Valve	1"	1"	\$ 42.74	\$ 39.32
PMMV200CF	2" x 2" Flange Ball Valve	2"	1 1/2"	\$ 60.38	\$ 55.55
PMMV220CF	2" x 2" FP Flange Ball Valve	2"	2"	\$ 80.64	\$ 74.19



Dry Spinner Spreader Parts and Upgrades

NUMBER	DESCRIPTION	APPLICATION	LIST	NOW
KK38260	LH Nutrient Applicator Distributor Disk	DN200, DN300, DN456, DN485, DS20, DS30	\$ 485.00	\$ 446.20
KK38259	RH Nutrient Applicator Distributor Disk	DN200, DN300, DN456, DN485, DS20, DS30	\$ 485.00	\$ 446.20
KK38601	Hydraulic Fan Disk Hub	DN200, DN300, DN456, DN485, DS20, DS30	\$ 80.00	\$ 73.60
KK37917	Right Hand Fin Blade	DN200, DN300, DN456, DN485, DS20, DS30	\$ 50.00	\$ 46.00
KK37918	Left Hand Fin Blade	DN200, DN300, DN456, DN485, DS20, DS30	\$ 50.00	\$ 46.00
KK38263	Right Hand Spinner Disk Kit	DN495, DS35	\$ 780.00	\$ 717.60
KK38264	Left Hand Spinner Disk Kit	DN495, DS36	\$ 780.00	\$ 717.60
KK38972	Seal Kit for Spinner Motor	DN200, DN300, DN456, DN485, DS20, DS30	\$ 145.00	\$ 133.40
KK38988	Bin Level Sensor	DN200, DN300, DN456, DN485, DS20, DS30	\$ 367.63	\$ 338.22
KK38986	Encoder Sender Kit	DN200, DN300, DN456, DN485, DS20, DS30, DS35	\$ 446.23	\$ 410.53
KK44204	Blade, Fin Kit	DN200, DN300, DN456, DN485	\$ 340.00	\$ 312.80
KK48414	Jack Assembly	DN200, DN300, DN456, DN485, DS20, DS30, DS35	\$ 395.00	\$ 363.40
KK38194	Straight Belt Conveyor Kit	DN200, DN300, DN456, DN485	\$ 2,395.00	\$ 2,203.40
KK38162	Belt-Over-Chain Conveyor Kit – 12' #4	DN200, DN300, DN456, DN485, DS20, DS30	\$ 4,925.00	\$ 4,531.00
KK38195	Belt-Over-Chain Conveyor Kit – 14' #4	DN495, DS35	\$ 5,585.00	\$ 5,138.20
KK38604	Hydraulic Flow Divider Valve	DN200, DN300, DN456, DN495, DS20, DS30	\$ 305.00	\$ 280.60
BKK11409	Dry Spreader Underframe Shield Kit	Sprayers and Applicators	\$ 4,178.67	\$ 3,844.38
High-Capacity Nutrient Applicator:				
AKK19918	Right Hand End Deflector	F4365	\$ 281.00	\$ 258.52
AKK19917	Left Hand End Deflector	F4365	\$ 313.69	\$ 288.59
AKK19919	Right Hand End Deflector	F4365	\$ 284.08	\$ 261.35
AKK19920	Left Hand End Deflector	F4365	\$ 284.08	\$ 261.35
AKK21767	Bin Level Sensor	800R, F4365	\$ 316.25	\$ 290.95
AKK33424	High Wear Blower Fan	800R, F4365	\$ 2,957.14	\$ 2,720.57
BKK11799	LH and RH High Wear Fan Housing	800R	\$13,827.00	\$12,720.84
BKK10955	Material Deflector Kit	800R, F4365	\$ 5,986.20	\$ 5,507.30
KK38332	Hydraulic Reservoir Filter Kit	F4365, DN495, DS35	\$ 235.00	\$ 216.20
KK38333	Hydraulic Reservoir Filter Element	F4365, DN495, DS35	\$ 40.00	\$ 36.80



Replacement Boom Cylinders

NUMBER	DESCRIPTION	APPLICATION	LIST	NOW
AHC20306	Inner Wing Fold Cylinder	4710, 4720, 4730, 4830	\$1,465.22	\$1,348.00
AN207541	Wing Level Tilt Cylinder	4920, 4930, 4940	\$1,745.71	\$1,606.05
AKK19552	Inner Wing Fold Cylinder	4630, R4023	\$2,082.73	\$1,916.11
AHC17652	Boom Lift Cylinder	R4023	\$1,381.07	\$1,270.58
AHC20269	Outer Boom Fold Cylinder	4630, R4023	\$1,049.14	\$ 965.21
AN209614	Outer Boom Fold Cylinder	4940	\$1,841.59	\$1,694.26
AHC21556	Hydraulic Fold Boom Cylinder	R4030, R4038, R4044, R4045, R4060, 400/600 Series	\$1,234.22	\$1,135.48
AHC13683	Boom Lift Cylinder	4940, R4030, R4038, R4044, R4045, R4060, 400/600 Series	\$1,847.75	\$1,699.93
AHC12506	Inner Wing Fold Cylinder	R4030, R4038, R4044, R4045, R4060, 400/600 Series	\$1,809.62	\$1,664.85
AHC19591	Inner Wing Fold Cylinder	R4030, R4038, R4044, R4045, R4060, 400/600 Series	\$1,388.14	\$1,277.09
AHC12507	Outer Boom Fold Cylinder	R4030, R4038, R4044, R4045, R4060, 400/600 Series	\$1,198.21	\$1,102.35

Your John Deere dealer can build hydraulic hoses in minutes.



HOSES IN MINUTES



John Deere hose assemblies built to OEM specifications.

Ask your dealer about hoses for any brand of equipment.

We follow through to deliver uptime for you.

Stay up and running, and eliminate the worry about contaminants entering your hydraulic system. Trust your John Deere dealer to deliver complete solutions, like Ultra Clean, that ensure contaminants are completely removed from new hose assemblies.

Ask your dealer how Ultra Clean means uptime.



Hose Drip Plugs

Prevent messes and environmental contamination from residual fluids leaking out of hydraulic hoses and/or hydraulic ports during repairs. An essential component of any well-stocked toolbox on the farm!



NUMBER	DESCRIPTION	LIST	NOW
SW304-257	Mini Drip Plug (1–10mm), Package of 24	\$71.60	\$65.87
SW304-258	Standard Drip Plug (5–22mm), Package of 12	\$71.60	\$65.87
SW304-259	Large Drip Plug (12–42mm), Package of 4	\$71.60	\$65.87
SW304-260	X-Large Drip Plug (50–80mm), Package of 3	\$71.60	\$65.87
SW304-262	Drip Plug Kit, Package Contains 6 Mini, 4 Standard, and 2 Large	\$71.60	\$65.87



SCV Coupler Conversion Kit 20, 30, and 40 Series Tractors

Convert traditional JD couplers to ISO couplers and add the convenience of connect-under-pressure by installing the ReNew2 Conversion Kit. Installs neatly in place without removing the original SCV housing and eliminates the need to use the locking levers. Includes color coded dust caps and plugs to keep contamination out of the couplers when not in use.

NUMBER	DESCRIPTION	LIST
SW315-196	20, 30, and 40 Series Tractors	\$331.49



Omni Hydraulic Multiplier Valves

The Omni hydraulic multiplier valve addresses the needs of the compact utility tractor owner. Take an existing single circuit and split it into two circuits with electric controls on any 12-volt electrical system. The Omni valve is designed to be used on open, closed, or PFC hydraulic systems.



NUMBER	MULTIPLIER VALVE TYPE	NUMBER OF FUNCTIONS	ADD-ON	LIST	NOW
SW757-1550	Standard	2	With RCS Handle	\$1,013.44	\$ 932.36
SW757-1552	Standard	4	With RCS Handle	\$2,057.80	\$1,893.18
SW757-1520	Economy	2	With Pendant Switch	\$ 683.97	\$ 629.25
SWSV30	Standard	2	4 Switch Options	\$ 419.97	\$ 386.37

Hydraulic Multiplier and Add-On Valves

Add additional hydraulic outlets to prime movers economically. Hydraulic multipliers are transparent to the hydraulic system and work safely on all makes of equipment. They're easy to operate and provide a no-hassle solution to mobile equipment hydraulic shortages. These units are 100% final product-performance tested, and components are ISO-9002 certified.



NUMBER	DESCRIPTION	LIST
SW700-1002	Economy Multiplier Valve with 2 Circuits. Works with Switchbox.	\$ 426.44
SW700-1510	Standard Multiplier Valve with 2 Circuits. Works with Switchbox and ISO Couplers.	\$ 769.77
SW700-1590	Standard Multiplier Valve with 2 Circuits. Works with John Deere Couplers.	\$ 704.71
SW700-1513	Standard Multiplier Valve with 3 Circuits. Works with Switchbox.	\$1,034.85
SW700-1553	Standard Multiplier Valve with 3 Circuits. Works with RCS Handle.	\$1,110.41

CLEAR THE AIR

WITH **CARBON FILTER PLUS**

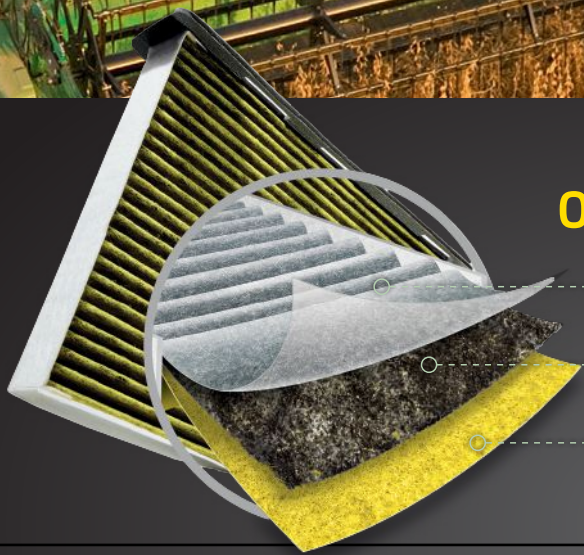

OUR PREMIUM CARBON FILTER FEATURES:

- PARTICLE FILTER LAYER
- ACTIVATED CARBON LAYER
- BIOFUNCTIONAL LAYER

Available for new and late-model **tractors, combines, sprayers, and other machines**. Carbon Filter Plus has three active layers to help keep out dust, dirt, and other contaminants — and limits the growth of mold and bacteria on the filter.

Visit your local John Deere dealer today.



JOHN DEERE

Keep your competitive equipment and trucks rolling with one-stop shopping.



Whether red, blue, or another color, you can find maintenance products for your competitive equipment and trucks at your John Deere dealer. With Plus-50™ II engine oil, Cool-Gard™ II coolant, and Fleetguard® filters, we have high-quality products available to keep your machines running. Contact your dealer today!

One Engine Oil For All.

It takes a special breed of oil to keep engines running in off-road conditions. That's because Plus-50™ II Oil is specially formulated to keep engines running smoothly and efficiently in extreme off-road conditions. Tractors, Semi trucks, UVs, and gasoline engine vehicles. Let John Deere Plus-50 II Oil be the one ENGINE oil for your farm. Talk to your dealer today.



John Deere Plus-50™ II Oil. Keep Running.

JohnDeere.com/Oil

JohnDeere.ca/Oil

Antifreeze/Coolant

Cool-Gard™ II High Performance Long-Life, Heavy-Duty Formula.

- Formulated for up to 6-years/6,000 hours* in cooling systems of diesel and gas engines
- Supports advanced engine technology
- Protects against corrosion and deposits
- Extends water pump life and prevents liner cavitation
- High thermal and oxidation protection
- Ready-to-use 50/50 premix formula for freeze protection down to -34°F (-37°C)
- Contains bittering agent to help discourage accidental ingestion
- Less toxic (PG) propylene glycol available for use around animals

*Rating applies when complete cooling system flush is performed prior to use.



Plus-50™ II 10W-30 & SAE 15W-40

Plus-50 II 10W-30 and SAE 15W-40 are made with a unique additive system that offers premium protection from deposits and wear. Exceeding API service classification CK-4/SN and high level performance under John Deere's Severe Off-Road Dyno test, this level of engine oil is excellent for diesel engines.

Available For Order

10W-30: 1-qt. (946ml) | 1-gal. (3.78L) | 5-gal. (18.9L) | 55-gal. (208L) | 275-gal. (1040L) Tote
 15W-40: 1-qt. (946ml) | 1-gal. (3.78L) | 2.5-gal. (9.46L) | 5-gal. (18.9L) | 30-gal. (113.6L) | 55-gal. (208L)

Please consult with your dealer or visit shop.deere.com for part numbers and pricing information.



Plus-50™ II Features & Benefits:

- Full fleet solution
- Compatible with both current, legacy and competitive machines
- Proven high-level performance in low-emission IT4 and FT4 engines
- Tested and developed for severe off-road applications
- Formula specifically created to stop engine wear, corrosion, sludge, soot, varnish and oxidation
- Drain interval extension up to 500 hours in a John Deere engine, using a John Deere filter.

Plus-50™ II Premium Synthetic Engine Oil: SAE 0W-40 & SAE 5W-40

Plus-50 II Premium Engine Oil offers two synthetic engine oil options to provide support on every farm, for every season. Our SAE 0W-40 option is a full synthetic PAO (Poly Alpha Olefin) based oil. Performing at a premium level in all climates, Plus-50 II SAE 0W-40 is specifically developed for those operating in extremely cold conditions.

Our newer Plus-50 II SAE 5W-40 option is an all-season full synthetic engine oil that provides excellent performance for customers who operate in extremely cold or hot conditions and want to maximize engine life performance in modern engines. SAE 5W-40 is also backwards compatible with our legacy machines as well.

Available For Order

0W-40: 1-qt. (946ml) | 1-gal. (3.78L) | 5-gal. (18.9L) | 55-gal. (208L) | 275-gal. (1040L) Tote
 5W-40: 1-gal. (3.78L) | 5-gal. (18.9L) | 55-gal. (208L)

Please consult with your dealer or visit shop.deere.com for part numbers and pricing information.



Torq-Gard™ II

Torq-Gard™ II engine oil provides up to 250 hours of performance and protection for diesel engines. It can be used in both on-road and off-road applications. This oil meets API service category CK-4 and is backwards compatible to meet previous categories as well. Torq-Gard™ II is formulated to provide excellent wear, oxidation, and deposit characteristics. Whether your machine is old or new, Torq-Gard™ II is for you!

Available For Order

5W-30: 1-qt. (946ml) | 5-gal. (18.9L)
 10W-30: 5-gal. (18.9L) | 55-gal. (208L)
 15W-40: 1-qt. (946ml) | 1-gal. (3.78L) | 5-gal. (18.9L) | 55-gal. (208L) | 275-gal. (1041L)

Please consult with your dealer or visit shop.deere.com for part numbers and pricing information.



Transmission and Hydraulic Oil

Hy-Gard™ oils are specifically developed to meet the exact requirements of transmissions, wet clutches, wet brakes, and hydraulic systems. Oils not meeting these exact specifications can compromise machine or component life.

Hy-Gard performance is tested in both lab and field. High-level performance meets high-standard approvals by John Deere engineers, allowing Hy-Gard to meet the increase in demand for performance and protection of transmission and hydraulic systems.



Available For Order

Hy-Gard: 1-gal. (3.78L) | 2.5-gal. (9.46L) | 5-gal. (18.9L) | 30-gal. (113.6L) | 55-gal. (208L) | 275-gal. (1041L) Tote

Low-Viscosity Hy-Gard: 1-qt. (946mL) | 1-gal. (3.78L) | 2.5-gal. (9.46L) | 5-gal. (18.9L) | 55-gal. (208L) | 275-gal. (1041L) Tote

Bio Hy-Gard II: 5-gal. (18.9L) | 55-gal. (208L)

Please consult with your dealer or visit shop.deere.com for part numbers and pricing information.

Product Features & Benefits

Hy-Gard:

Recommended for equipment with common system reservoirs or separate transmission hydraulic systems

Exceeds JDM J20C specifications

Low-Viscosity Hy-Gard:

Hy-Gard oil alternative in cold weather. Exceeds JDM J20C specifications

Bio Hy-Gard II:

Canola-based oil & 94% biodegradable. Use in place of mineral-based hydraulic oils.

Bulk Oil. A New Opportunity

Is handling and storing your packaged oil a hassle? Are partially filled packages and boxes consuming your storage space?

If the answer is yes, it's time to consider bulk oil. With Plus-50™ II, Hy-Gard™ – or any other bulk premium John Deere lubricant available – you have the opportunity to nearly eliminate the headache of disorganized packaged products in your shop. Plus, you'll have more product inventory control, eliminate unnecessary waste and you'll reduce the risk of product contamination.

Make the Leap!

Contact your local dealer today about bulk oil availability.



Grease

John Deere grease is precisely formulated to meet the demanding lubrication needs for tough off-road and on-road conditions. Choosing the right high-quality John Deere grease could show you cost savings, longer equipment life, reduced down time, and lower equipment operational cost.

BEST CHOICE: Multi-Purpose Severe-Duty (SD) Polyurea Grease and Extreme-Duty (ED) Synthetic Grease.

John Deere's best multi-purpose grease is ideal for use in high-temperature and extreme pressure applications. Best if used for U-joints, wheel bearings, and other grease points requiring severe-duty applications.



NUMBER	DESCRIPTION	SIZE	LIST
Multi-Purpose Grease:			
TY6341	Severe-Duty Polyurea Grease	14-oz. (397 g) Cartridge	\$ 7.44
TY25744	Extreme-Duty Synthetic Grease	14-oz. (397 g) Cartridge	\$17.31
TY24416	Heavy-Duty Lithium Complex Grease	14-oz. (397 g) Cartridge	\$ 6.71
PT507	Multi-Purpose Lithium Grease	14-oz. (397 g) Cartridge	\$ 6.00
Specialty-Purpose Grease:			
TY24425	Heavy-Duty Water-Resistant Grease	14-oz. (397 g) Cartridge	\$ 5.37
AN102562	Corn Head Grease	14-oz. (397 g) Cartridge	\$ 7.13
TY6333	Heavy-Duty Lithium Complex 3% Moly Grease	14-oz. (397 g) Cartridge	\$ 8.47
TY27373	Calcium Sulfonate Grease with 5% Moly	15-oz. (425 g) Cartridge	\$ 9.91

GL-5 and Synthetic GL-5 Gear Lube

GL-5 and Synthetic GL-5 lubricant is designed for severe on- and off-highway applications. Its superior thermal stability and oxidation resistance keeps gears and seals clean, while its thermal durability protects gears from physical damage by preventing heat-induced failure of anti-wear chemistry.

NUMBER	DESCRIPTION	SIZE	LIST
Synthetic GL-5 Gear Lube:			
TY26372	80W-140	1-qt.	\$ 28.19
TY26373	80W-140	5-gal.	\$ 483.71
TY26374	80W-140	16-gal.	\$1,602.30
TY26375	75W-90	1-qt.	\$ 30.84
TY26376	75W-90	5-gal.	\$ 496.71
TY26377	75W-90	16-gal.	\$1,574.74
GL-5 Gear Lube:			
TY6296	80W-90	1-qt.	\$ 12.06
TY26815	80W-90	1-gal.	\$ 40.62
TY26816	80W-90	5-gal.	\$ 197.42
TY26817	80W-90	30-gal.	\$1,051.79
TY6345	85W-140	1-qt.	\$ 11.35
TY26812	85W-140	1-gal.	\$ 41.65
TY26813	85W-140	5-gal.	\$ 194.17
Synthetic Gear Lubricant for Combine Feederhouse Drives:			
TY26408	HD460	1-qt.	\$ 37.05





Antifreeze/Coolant

Cool-Gard™ II High Performance Long-life, Heavy-duty Formula.

Product Features & Benefits

- Formulated for up to 6-years/6,000-hours* life in cooling systems of diesel and gas engines
- Supports advanced engine technology
- Protects against corrosion and deposits
- Extends water pump life and prevents liner cavitation
- High thermal and oxidation protection
- Ready-to-use 50/50 premix formula for freeze protection down to -34°F (-37°C)
- Contains bittering agent to help discourage accidental ingestion
- Less toxic (PG) propylene glycol available for use around animals

NUMBER	DESCRIPTION	SIZE	LIST
Cool-Gard II:			
TY26573	Concentrate	1-gal. (3.78L)	\$ 30.03
TY26574	Concentrate	55-gal. (208L)	\$1,508.27
TY26575	Pre-mixed	1-gal. (3.78L)	\$ 18.24
TY26576	Pre-mixed	2 1/2-gal. (9.46L)	\$ 43.64
TY26577	Pre-mixed	55-gal. (208L)	\$ 899.88
TY26578	Pre-mixed	330-gal. Tote (1249L)	\$5,219.15
TY26968	PG, Pre-mixed	1-gal. (3.78L)	\$ 28.31
TY26969	PG, Pre-mixed	55-gal. (208L)	\$1,482.52
TY26970	PG, Pre-mixed	330-gal. Tote (1249L)	\$8,798.96

*Rating applies when complete cooling system flush is performed prior to use.

New Improved Keep Clean Diesel Fuel System Cleaner

Expect the following...

- Improved fuel economy
- Protects engines and injectors from the formation of harmful deposits
- Restores injector and combustion performance by removing harmful deposits
- Extends the life of the fuel system by preventing corrosion
- Helps prevent unscheduled maintenance, filter blocking, & DPF regeneration by keeping fuel systems clean



NUMBER	SIZE	LIST
TY27837	32-oz.	\$ 22.63
TY27838	1-Gallon	\$ 53.45
TY27839	5-Gallons	\$ 286.47
TY27840	55-Gallons	\$2,365.37

John Deere Fuel-Protect Gasoline Stabilizer

Blended fuel attracts water from the air, which causes corrosion to fuel tanks, fuel lines, carburetors, and injectors. John Deere Fuel-Protect contains double the corrosion preventer to help fight these damaging effects. Pumped gasoline starts to degrade immediately, causing varnish deposits to build in engines. This results in starting problems, poor performance, and reduced engine life. Add John Deere Fuel-Protect to keep fuel fresh for 12 months, more than doubling the storage life of fresh gasoline. John Deere Fuel-Protect also eliminates the need to drain fuel prior to storage.



NUMBER	DESCRIPTION	LIST
TY27534	Fuel-Protect for Gasoline, 8-oz.	\$ 6.20
TY27535	Fuel-Protect for Gasoline, 32-oz.	\$16.67

TESTED TO THE EXTREME TO HANDLE THE EXTREME.



Get your day off to a running start with **StrongBox™** batteries from John Deere. Whether you choose premium **Original Equipment** or economical **Standard-Duty**, you'll receive the best battery for your machine. More durable. More dependable. That's StrongBox.

ORIGINAL EQUIPMENT

- Premium Battery
- Heavy-Duty Equipment
- John Deere Specifications
- Higher Cold-Cranking Amps
- Longer Warranty

STANDARD-DUTY

- Economical Alternative Battery
- Light-Duty/Older Equipment
- Industry Standard Specifications & Warranty

Contact us today for more information or go to JohnDeere.com/batteries.



StrongBox™ Original Equipment

StrongBox™ Original Equipment batteries are factory tested to meet the demanding machine specifications of your John Deere Equipment; Heavy- and light-duty farm, ranch, construction, utility, and lawn and garden.

NUMBER	BCI	CCA	WARRANTY*
Heavy-duty Commercial Applications:			
TY21734B	4	975	12
TY21741B	30H	650	18
TY21764B	24	550	18
TY23020B	4D	1400	12
TY23025B	5D	1000	12
TY24341B	3ET	620	12
TY24381B	4DLT	1000	12
TY24546B	31T	950	20
TY25272B	27	675	18
TY25879B	31	950	20
TY26442B	34	800	15
TY26773B	D01	800	6
TY26782B	D4	1150	12
TY26783B	D5	1400	12
TY21737B	3EH	850	12
Turf & Utility Applications:			
TY25221B	U1	350	6
TY25876B	51	500	18
TY25881B	45	480	12
TY26498B	22NF	500	12
TY27365B	GC	N/A	6

*Warranty free replacement months.

[See us for pricing.](#)

StrongBox™ Standard-Duty

StrongBox™ Standard-Duty batteries are an economical alternative to the StrongBox™ Original Equipment batteries and are available for a variety of light-duty use applications; agricultural, commercial, and turf & utility.



NUMBER	BCI	CCA	WARRANTY*
Commercial Applications:			
TY21731B	1	640	12
TY21748B	8D	1400	12
TY21754B	4D	1050	12
TY27793B	5D	880	6
TY27794B	3ET	460	9
TY27797B	34	690	12
TY27805B	27	600	12
TY27829B	4DLT	860	9
TY27796B	31	925	18
TY27795B	31T	925	18
TY6192B	22F	425	12
Turf & Utility Applications:			
TY25878B	U1	300	6
TY27474B	49/H8	900	20
TY27798B	22NF	360	6
TY27800B	26R	540	20
TY27806B	51	425	15
TY27801B	Motorcycle	50	6

*Warranty free replacement months.

[See us for pricing.](#)

StrongBox™ Truck/SUV

StrongBox™ Truck/SUV batteries are available in a variety of sizes and will fit most automotive models. See your local dealer to find the battery that fits your vehicle needs.



NUMBER	BCI	CCA	WARRANTY*
Ford			
TY24932B	65	850	30
Chevy/GMC			
TY27473B	48	730	30
TY24937B	78DT	800	30
Dodge Ram			
TY24937B	78DT	800	30
TY27804B	94R/H7	790	30
Toyota/Nissan			
TY24394B	24F	710	30
TY27799B	27F	700	30

*Warranty free replacement months.

See us for pricing.

New StrongBox™ AGM Batteries

We're excited to introduce new StrongBox™ AGM (absorbed glass mat) batteries.

Key features and benefits of AGM batteries:

- Offer greater vibration resistance, longer battery life, and therefore increased uptime
- Offer greater power which is beneficial in extremely cold temperatures as the design is more efficient
- Are completely sealed, which means maintenance-free operations with little to no gassing (no need to add water)
- Have a longer shelf life due to a lower self-discharge rate

NUMBER	BCI	CCA	WARRANTY*
TY27863B	31	925	36
TY27877B	H9/L6	950	36
TY27880B	31T	925	36

*Warranty free replacement months.

See us for pricing.



Battery Accessories

Make John Deere your one-stop shop for battery accessories. Our wide selection of battery accessories includes terminals, terminal brushes, bolts, corrosion preventative, and terminal cleaner—everything you need! See us today for the complete Battery Accessories lineup.



John Deere—your hardware headquarters.

See your John Deere dealer for two easy, cost-saving ways to stock up on hardware for your farm and shop:

1) Grab what you need and pay by the pound.

- Bolts
- Fender washers
- Wing nuts
- Plow bolts
- Flat washers
- Nylon nuts
- Carriage bolts
- Lag screws
- And more!
- Lock washers
- Hex nuts

2) Customize your own hardware needs.

Make us your one-stop shop. See us today for great savings and added accessibility.



Customize your own Hardware Bins and Hardware

Keep your assortments even more organized with our sturdy storage bins. They're a great addition to any shop!



72-hole storage bin
Part number: PM15462
36-in. (W) x 12-in. (D) x 42-in. (H)



40-hole storage bin
Part number: PM15463
36-in. (W) x 12-in. (D) x 21 1/2-in. (H)



Base for 40- and 72-hole storage bins
Part number: PM15464
36-in. (W) x 12-in. (D) x 4 1/2-in. (H)

ENGLISH

Grade 5 – Green



Grade 5 Carriage – Green



Grade 8 – Blue



Stainless Steel Carriage



METRIC

Grade 8.8 Metric – Red



Grade 8.8 Metric Carriage – Red



Grade 10.9 Metric Flange – Black



Grade 10.9 Metric Hex – Black



Preselected Hardware Assortments

English

Grade 5 hex, 1/4–1/2-in. dia.

Part No. PM15472

Sizes in assortment: 99

Metal bins included: 40- and 72-hole

Grade 5 hex, 5/8–3/4-in. dia.

Part No. PM15473

Sizes in assortment: 36

Metal bins included: 40-hole

Grade 5 carriage, 1/4–1/2-in. dia.

Part No. PM15474

Sizes in assortment: 36

Metal bins included: 40-hole

Grade 8 hex, 1/4–1/2-in. dia.

Part No. PM15475

Sizes in assortment: 70

Metal bins included: 72-hole

Grade 8 hex, 5/8–3/4-in. dia.

Part No. PM15476

Sizes in assortment: 25

Metal bins included: 40-hole

Metric

Grade 8.8 hex, M6–M12 dia.

Part No. PM15477

Sizes in assortment: 70

Metal bins included: 72-hole

Grade 8.8 hex, M16 dia.

Part No. PM15478

Sizes in assortment: 19

Metal bins included: 40-hole

Grade 8.8 carriage, M6–M16 dia.

Part No. PM15479

Sizes in assortment: 34

Metal bins included: 40-hole

Grade 10.9 flange, M6–M12 dia.

Part No. PM15480

Sizes in assortment: 40

Metal bins included: 40-hole

Grade 10.9 hex, M6–M12 dia.

Part No. PM15481

Sizes in assortment: 58

Metal bins included: 72-hole

Grade 10.9 hex, M16–M20 dia.

Part No. PM15482

Sizes in assortment: 32

Metal bins included: 40-hole

See us for pricing.

NEW Voyager® 7" WiSight® 2.0 Observation System

We're excited to introduce a new Voyager® 7" WiSight® 2.0 camera system. It's great for viewing in hard to see places. Ideal for tractors, sprayers, combines, implements, trucks/trailers etc.

Key features and benefits:

- Voyager 7" color monitor
- Increased views by connecting up to four wireless cameras at the same time using single, split, or quad view.
- Waterproof camera
- Excellent low-light performance using infra-red LED

Please note, the plastic bracket included in the kit that holds the monitor is not made for the heavy-duty market. It is intended for light-duty use only.

Customers who wish to use this kit for heavy-duty use should use a ram mount or versa mount. See dealer for suggestions of brackets for heavy-duty use.



NUMBER	DESCRIPTION	LIST	NOW
SWWVSXS70	Voyager® 7" WiSight 2.0 Camera System. Includes 7" monitor, wireless camera, light-duty mounting bracket.	\$654.81	\$615.52
SWWVSXM70	Voyager® 7" Wireless Monitor	\$396.08	\$372.32
SWWVXC150	Voyager® Wireless Camera 2.0	\$326.41	\$306.83

John Deere Two-Way Radios from Midland®

Two-way communication devices can be used for small-medium farms and job sites, making it easier for multiple people to communicate and targeting areas with poor cellular coverage.

Key features and benefits:

- Triple the range of traditional CB Radios and more
- License free FRS radio. Works with other FRS/GMRS radios
- 36 channels (14 extra channels)
- Xtreme Range – Up to 38 miles – Longer range communication in open areas with little or no obstruction
- 121 privacy codes – Gives you up to 2,662 channel options to help you block other conversations
- Long battery life – (up to 15-hours) HI/LO power settings – Lets you adjust transmit power & conserve battery life



NUMBER	DESCRIPTION	LIST	NOW
PMT71VP3AG	Two-Way Radio, Handheld, AG Green	\$99.38	\$79.50
PMT71VP3CF	Two-Way Radio, Handheld, CF Yellow	\$99.38	\$79.50

NOCO® Lithium Jump Starters



NUMBER	PEAK AMPS	PRIMARY EQUIPMENT TYPES	ENGINE SIZE CAPABILITIES	LIST
12V Jump Starters:				
A-GB20	500A	Lawn and Garden, Auto	Up to 4L Gas Engine	\$ 93.75
A-GB40	1,000A	Lawn and Garden, Small Tractors, Gators, Auto	Up to 6L Gas, 3L Diesel	\$ 116.74
A-GB50	1,500A	Lawn and Garden, Small Tractors, Gators, Auto	Up to 7L Gas, 4.5L Diesel	\$ 174.17
A-GB70	2,000A	Lawn and Garden, Small and Large Tractors, Gators, Auto	Up to 8L Gas, 6L Diesel	\$ 231.59
A-GB150	4,000A	Lawn and Garden, Small and Large Tractors, Gators, Skid Loaders, Auto	Up to 10L Gas, 10L Diesel	\$ 346.42
12V/24V Jump Starter:				
A-GB500	20,000A	Large Agriculture, Construction and Forestry	Up to Class 8+ Engines	\$2,178.14



Material Collection System

Expand the versatility of your lawn tractor with a Material Collection System. Bagging quickly picks-up grass for a clipping-free finish. Ditch the rake and make fall leaf cleanup a breeze.



NUMBER	COMPATIBLE MODELS	LIST
BG20755	Z335E, Z335M, Z345M, Z345R	\$1,292.56
BG20757	BG20757: Z525E, Z535M, Z535R, Z540M, Z540R	\$ 860.29
BM20671	X465, X475, X485, X495, X575, X585, X595, X700's	\$1,218.73
BM21680	X500, X520, X530, X534, X540, X570, X580, X584, X590, GX325, GX335, GX345, GX355, 325, 335, 345, 355D	\$1,178.07
BM23634	Z225, Z245, Z425, Z435, Z445, Z625, Z645, Z655	\$ 908.43
BUC10925	Z720E, Z730M, Z735E, Z735M, Z740R	\$1,277.59
BUC11233	X300's	\$ 602.41
BUC11342	Z315E, Z320M, Z320R, Z370R	\$ 900.94
BUC11344	Z325E, Z330M, Z330R	\$1,399.56
BUC11355	Z325E, Z330M, Z330R	\$1,399.56
BUC11514	Z740R, Z760R	\$1,186.63



MowerPlus™ Smart Connectors

MowerPlus™ is the app you need to keep your John Deere riding mower running well and your lawn looking great. It tracks and records yard tasks and serves as a one-stop shop for seasonal care tips and maintenance activities.

Know your mower and know how you mow with the John Deere MowerPlus app.

Contact your Dealer today!

NUMBER	DESCRIPTION	APPLICATION	LIST
BUC10537	Bluetooth® Module for Select-Series	X300-, X500-Series	\$109.14
BUC10510	Bluetooth® Module 100-Series	100-Series	\$ 96.30



Power and Protection

Get your guard up with a full array of custom protection options that look great, too.

NUMBER	DESCRIPTION	APPLICATION	LIST
BUC10772	Cargo Box Power Lift	XUV835/865	\$1,122.43
BUC10682	WARN® ProVantage 2041 (4,500-lb.) Winch	XUV835/865	\$ 890.24
BM21392	Winch Accessories Kit	XUV835/865	\$ 174.41
BUC10679	Brush Guard	XUV835/865	\$ 478.29
BM22841	Brush Guard	XUV825/855, HPX	\$ 337.06
BM23365	Brush Guard	XUV560/590	\$ 441.91
BM22767	Rear Bumper	XUV835/865/825/855	\$ 260.01
BM23362	Rear Bumper	XUV560/590, RSX	\$ 260.01
BUC11656	Front Fender Guard	XUV835/865	\$ 267.80
BM23394	Front Fender Guard	XUV560/590	\$ 246.10
BUC11320	Cargo Box Fender Guard	XUV835/865	\$ 228.99
BM22811	Cargo Box Fender Guard	XUV825/855, TX/TE	\$ 258.94
BUC10761	CV Guards – Front and Rear	XUV835/865	\$ 301.74

OPS Windshield Options

Choose one of two OPS windshields for added comfort and protection. Additionally, one of these windshields should be selected to complete the OPS Poly Cab.



NUMBER	DESCRIPTION	APPLICATION	LIST
BM25922	OPS Full No-Scratch Windshield	XUV625i, XUV825i, XUV855D, XUV825i S4, XUV855D S4	\$ 809.99
BUC10210	OPS Glass Windshield with Wiper	XUV625i, XUV825i, XUV855D, XUV825i S4, XUV855D S4	\$1,520.47
BM25103	OPS Windshield Washer Kit	For use with OPS Glass Windshield with Wiper	\$ 420.51
BM24089	OPS Switch Bank	Required for Windshield Washer Kit	\$ 97.37

Floor Mats

Washable rubber floor mats provide an added layer of protection to the floor of the vehicle, guarding against dents, dings, and scratches.



NUMBER	DESCRIPTION	APPLICATION	LIST
BM25743	Floor Mat – Front	XUV550, XUV560, XUV590i, RSX850i, RSX860i	\$110.21
BM25744	Floor Mat Kit	XUV590i S4	\$222.56
BM24282	Floor Mat – Front	XUV 625i, 825i, 825i S4, 855D, 855D S4	\$110.21
BM24283	Floor Mats – Rear	XUV 825i S4, 855D S4	\$110.21
BUC11319	Floor Mats (2)	XUV835/865	See Us

Cargo Box Protection

Protects cargo bed from scratches and dents. The mats may also help keep materials from sliding around during transport.



NUMBER	DESCRIPTION	APPLICATION	LIST
BM22772	Cargo Box Bed Mat	XUV835, XUV865, XUV825, XUV855, HPX615, HPX815, TX 4X2, TH 6X4/Diesel, TE 4X2	\$167.99
VGB10133	Cargo Box Bed Mat	TS 4x2	\$167.99
BM23371	Cargo Box Mat	XUV560/S4, XUV590/S4, RSX860	\$167.99
BM25048	Poly Bedliner	TS 4X2	\$459.03

Cargo Box Toolboxes

Provides more integrated sealed storage in the cargo box.

NUMBER	DESCRIPTION	APPLICATION	LIST
BUC11671	Top-Opening Toolbox	Heavy-Duty XUVs, TX, TX Turf, TE, and TH Models	\$1,480.69
BUC11670	Side-Opening Toolbox	Heavy-Duty XUVs, TX, TX Turf, TE, and TH Models	\$1,445.49
BUC10393	Tailgate with Brake and Tail Lights	Heavy-Duty XUVs, TX, TX Turf, TE, and TH Models	\$ 481.50
BM26220	Label Kit – Green and Yellow	Heavy-Duty XUVs, TX, TX Turf, TE, and TH Models	\$ 35.31



Cargo Box Divider

The dividers can be positioned at the front or rear of the cargo box bed. To change positions of the dividers, simply release the speedrail locks by hand and slide into the new position, then close the locks to secure the dividers.

NUMBER	DESCRIPTION	APPLICATION	LIST
BM22769	Cargo Box Divider	Compatible with models equipped with the Deluxe Cargo Box: Model year 2011 and later XUV625i, 825i, 825i S4, 855D, and 855D S4; Model year 2010 and later TX 4X2, TH 6X4 Gas, TH 6X4 Diesel, TE 4X2, and TX Turf	\$277.13



Stereos & Speakers

Enhance your Gator™ by adding a radio and speaker kit. Never be far from your favorite music or podcast with SWJHD1620, which is iPod® device ready. BM23379 includes lights, speakers, and a convenient netted pouch for extra storage.

NUMBER	DESCRIPTION	LIST	NOW
BUC10619	Premium Speaker Kit	\$1,224.09	
BM23379	Stereo and Speaker Kit	\$ 985.47	
SWJHD22	Stereo, Heavy-Duty AM/FM/Weatherband/Auxiliary	\$ 245.03	\$230.33
SWJHD62	Stereo, Heavy-Duty AM/FM/Weatherband/CD/SiriusXM® Satellite/USB 2.0	\$ 289.99	\$272.59
SWJDABIPDL	iPod Adaptor Cable for SWJHD1620 and SWJHD3620	\$ 45.84	\$ 43.09

Weatherproof Bluetooth® Amplifier and Heavy-Duty Mini Speakers

The weatherproof SWJAHD240BT is on the forefront of technology with integrated Bluetooth technology allowing users to stream their audio content using a Bluetooth-enabled device. Pair this amplifier with the 3.5" SWJXHD35 heavy-duty mini-box speakers, and it will offer a full range of audio entertainment. These speakers are exclusively designed to withstand the challenges of off-road and outdoor environments.

NUMBER	DESCRIPTION	LIST	NOW
SWJAHD240BT	Weatherproof Bluetooth® Amp	\$130.97	\$123.11
SWJXHD35	Weatherproof 3.5" Heavy-Duty Mini Speakers*	\$ 88.51	\$ 83.20
SWHD240BTKIT	Bluetooth® Amp and 3.5" Heavy-Duty Mini Speakers* Kit	\$219.69	\$206.51

* Heavy-Duty Mini Speakers sold as pair.



Cleaners, Chemicals, and Protectants

John Deere understands what it takes to have a successful operation—in the field and in the shop. That’s why we offer powerful cleaners and reliable lubricants. Two of our most popular products, John Deere Classic Glass Cleaner and All-Purpose Cleaner, can do wonders in the shop and in your cab. Make sure you give them a try.



NUMBER	DESCRIPTION	LIST	NOW
TY26350	Chain and Cable Lubricant, Aerosol	\$ 9.97	\$ 9.17
TY26352	All-Purpose Cleaner	\$10.34	\$ 9.51
TY26632	Electronic Contact Cleaner	\$ 9.81	\$ 9.03
TY26101*	Brake & Parts Cleaner	\$ 7.72	\$ 7.10
TY26357	Engine Cleaner	\$ 7.63	\$ 7.02
TY16403	Carpet Stain Remover	\$ 8.35	\$ 7.68
TY6350	Multi-Purpose Spray Lubricant, Aerosol	\$12.33	\$11.34
TY26355*	Carburetor and Choke Cleaner	\$ 4.99	\$ 4.59
TY26353	Penetrating Oil	\$ 9.13	\$ 8.40
TY25684	Classic Glass Cleaner	\$ 5.16	\$ 4.75
TY26595	Multi-Purpose Degreaser	\$ 9.34	\$ 8.59

* Not available in all areas.

Windshield Wash & Deicer

John Deere Windshield Washer Fluid & Deicer melts frost and ice on windows and wipers, reduces dangerous re-freeze, harmless to vehicle finish, and is rated at -20°F (-29°C).



NUMBER	SIZE	LIST	NOW
TY27865	1-Gallon	\$5.71	\$5.42

*Please Note – Due to state VOC restrictions, windshield washer fluid cannot be sold in California, Oregon, and Texas.

Andy Clean High Performance Soap

As Andy always says, “Farming doesn’t have to be dirty!” Andy Clean’s advanced deep cleaning technology foam cleaner is safe on all vehicle surfaces with superior protection against mother nature. All ingredients are sourced from US and Canada. #AndyClean



NUMBER	SIZE	LIST	NOW
PMH4300	1-Gallon	\$ 52.86	\$ 50.22
PMH4302	5-Gallon	\$240.55	\$228.52

*John Deere’s Pressure Washer Foam Cannon is also available: Part number AWJ-0018-0459 (1.09L, 37-oz.)

Protect your most valuable assets with John Deere paint.



You already know farm machinery is your largest investment. So get the most out of it today—and for seasons to come—by protecting it with the best paint in the business.

Only genuine John Deere paint gives you the long-lasting, high-gloss finish that better shields your equipment from UV fading, rust, and corrosion. Or whatever else Mother Nature may throw at you.

Pick up a can now at your local John Deere dealer. Better yet... make it two cans.

Only from your John Deere dealer.

SOFT BLACK COATING

Keep your tillage equipment corrosion-free throughout the dormant season with Soft Black protectant from John Deere. Our non-clog formula applies easier and lasts longer—until it's time to get back into the soil.



Oil-Less Air Compressors

- High performance induction electric motor
- Quiet Technology — Significantly quieter than standard air compressors
- 1-year limited warranty



HR1-20Q



HR1-20Q

Purchase a Oil-Less Air Compressor
HR1-2Q or HR1-20Q and
Receive a **\$25 Rebate***
*See insert coupon for details.

NUMBER	DESCRIPTION	LIST
HR1-2Q	1.0-hp Electric Motor, 120-volt, 2.4 cfm @ 90 psi 2.5-U.S. gal. Hand-Carry Model	\$295.00
HR1-20Q	1.5-hp Electric Motor, 120-volt, 4.0 cfm @ 90 psi 20-U.S. gal. Portable Model	\$546.00

Air Compressors

- 1-year warranty on HR-Series
- 1-year limited warranty and 2-year limited warranty on the engine on PR-Series
- 2-year warranty on AC-Series



PR1-BGM



AC2-80ES-1

NUMBER	DESCRIPTION	LIST
HR1-5E	2.0-hp Electric Motor, 120-volt, 4.1 cfm @ 100 psi, 5-U.S. gal. Hand-Carry Model	\$ 640.00
HR1-20E	2.0-hp Electric Motor, 120-volt, 4.1 cfm @ 100 psi, 20-U.S. gal. Portable Model	\$ 829.00
PR1-8GM	John Deere Branded 212-cc Engine, 7.5 cfm @ 100 psi, 8-U.S. gal. Portable Model	\$1,119.00
PR2-8GM	John Deere Branded 300-cc Engine, 17.2 cfm @ 175 psi, 8-U.S. gal. Portable Model	\$1,878.00
AC1-5GH	Honda GX 118-cc Engine, 4.4 cfm @ 100 psi, 5-U.S. gal. Hand-Carry Model	\$1,341.00
AC1-8GH	Honda GX 196-cc Engine, 13.1 cfm @ 100 psi, 8-U.S. gal. Wheelbarrow Model	\$1,341.00
AC2-8GH	Honda GX 270-cc Engine, 17.2 cfm @ 175 psi, 8-U.S. gal. Wheelbarrow Model	\$2,376.00
AC1-20GH	Honda GX 196-cc Engine, 13.1 cfm @ 100 psi, 8-U.S. gal. Portable Model	\$1,538.00
AC2-20GH	Honda GX 270-cc Engine, 17.2 cfm @ 175 psi, 20-U.S. gal. Portable Model	\$2,510.00
AC2-20GHS	Honda GX 270-cc Engine, 17.2 cfm @ 175 psi, 20-U.S. gal. Stationary Model	\$2,394.00
AC2-30GHS	Honda GX 389-cc Engine, 29.0 cfm @ 175 psi, 30-U.S. gal. Stationary Model	\$2,991.00
AC2-30KDS	Kohler OHV 9.1 HP Diesel Engine, 29.0 cfm @ 175 psi, 30-U.S. gal. Stationary Model	\$5,894.00
AC2-80ES	5.0-hp Electric Motor, 230-volt, 16.9 cfm @ 175 psi, 80-U.S. gal. Vertical Stationary Model	\$3,146.00
AC2-80ES-1	7.5-hp Electric Motor, 230-volt, 23.5 cfm @ 175 psi, 80-U.S. gal. Vertical Stationary Model	\$3,632.00

Air Tools

Short Impact Wrenches allow for easy access in confined spaces.

- **AT-3118-J** – 3/8-inch Short Impact Wrench
- **AT-3119-J** – 1/2-inch Short Heavy-duty Impact Wrench

Angle Impact Wrenches feature a gearless angle head reduces vibration and increases torque output. They also allow easy access in confined spaces, short and stubby design with low reaction force.

- **AT-3120-J** – 3/8-inch Angle Air Impact Wrench
- **AT-3121-J** – 1/2-inch Angle Air Impact Wrench

Heavy Duty Impact Wrench has enough power to bust loose even the toughest of fasteners. It also features excellent power to weight ratio.

- **AT-3122-J** – 3/8-inch Angle Air Impact Wrench

The **AT-3113-J** – 3/8-inch Butterfly Impact Wrench features an instant forward/reverse with butterfly throttle and comes in a compact size for access in tight areas.

The **AT-3207-J** – 3/8-inch Power Ratchet Wrench features a lever-type throttle for convenient operation and a front exhaust that directs air away from the operator.

The **AT-3206-J** – 1/2-inch Power Ratchet Wrench has an extended tool length that provides increased leverage and a steel ratchet housing for long life.



AT-3119-J



AT-3121-J



AT-3122-J



AT-3207-J



AT-3206-J



AT-3113-J

NUMBER	DESCRIPTION	LIST
AT-3207-J	3/8-in. Power Ratchet Wrench	\$234.00
AT-3113-J	3/8-in. Butterfly Wrench	\$ 94.00
AT-3206-J	1/2-in. Power Ratchet Wrench	\$234.00
AT-3118-J	3/8-in. Short Impact Wrench	\$193.00
AT-3119-J	1/2-in. Short Heavy-Duty Impact Wrench	\$193.00
AT-3120-J	3/8-in. Angle Air Impact Wrench	\$247.00
AT-3121-J	1/2-in. Angle Air Impact Wrench	\$247.00
AT-3122-J	1/2-in. Heavy-duty Air Impact Wrench	\$200.00

Bench Vise

Get a grip. Now go to work.

If you can't grip it, it can be mighty hard to work it. That's why a John Deere vise belongs on your work bench.

NUMBER	DESCRIPTION	LIST
BV5-J	5-in. Heavy-Duty Bench Vise, 10-year Warranty	\$172.00
BV8-J	8-in. Heavy-Duty Bench Vise, 10-year Warranty	\$253.00

Purchase a John Deere Bench Vise
 Receive a **\$15 Rebate*** on a **BV5-J** or
 Receive a **\$20 Rebate*** on a **BV8-J**.
*See insert coupon for details.



NEW Inverter Generators

New 2500-, 4000-, and 7300-watt inverter generators are now available.

These inverters provide clean and quiet power for recreational activities, home, and/or business. They are equipped with carbon monoxide detection and auto shutdown.

Inverter generators have the added benefit of being much quieter than standard portable generators.

With a John Deere inverter generator, you can be sure you're getting the power you need without worrying about excessive noise disturbing your neighbors, guests, or wildlife.



PR-G2500I



PR-G4000I



PR-G7300I

Features and Benefits

- INVERTER TECHNOLOGY — Reduced size, weight, noise and fuel consumption while producing commercial quality AC power for sensitive electronic equipment.
- Low-oil shutdown
- Recoil start (PR-G4000I and PR-G7300I models also have electric start – sealed battery included)
- Parallel Ports (PR-G2500I and PR-G4000I models, parallel port boxes sold separately)
- Outlet covers
- Equipped with CO detector with automatic shutdown
- DC plug
- USB port for electronics
- Idle control
- Digital display for voltage, hertz, run hours, and total hours (PR-G4000I and PR-G7300I models)
- Main circuit breaker
- USDA/USFS-approved spark arrestors
- ETL Certified

NUMBER	DESCRIPTION	LIST
PR-G2500I	2500 Max Watt Portable Inverter Generator; 220cc OHV Engine; 1.0-gallon Fuel Tank; 5.0-hour Run Time @ Half Load	\$1,095.00
PR-G4000I	4000 Max Watt Portable Inverter Generator; 225cc OHV Electric Start Engine; 2.1-gallon Fuel Tank; 8.0-hour run time @ Half Load; Idle Control and Wheel Kit Standard	\$1,585.00
PR-G7300I	7300 Max Watt Portable Inverter Generator; 420cc OHV Electric Start Engine; 5.5-gallon Fuel Tank; 9.0-hour Run Time @ Half Load; Idle Control and Wheel Kit Standard	\$2,595.00

Ratchet and Socket Sets

NUMBER	DESCRIPTION	LIST
TY25835	21-piece SAE 1/4-in. Socket Set with Case; 3/16-in.—1/2-in.	\$ 80.09
TY25836	21-piece Metric 1/4-in. Socket Set with Case; 5mm–13mm	\$ 80.09
TY25837	20-piece SAE 3/8-in. Socket Set with Case; 3/8-in.—13/16-in.	\$106.37
TY25838	22-piece Metric 3/8-in. Socket Set with Case; 10mm–21mm	\$104.29
TY25839	SAE 1/2-in. Drive, 6-pt & 12-pt Socket Set, 25-pc; 7/16-in.—1 1/4-in. Regular; 1/2-in.—1 5/16-in. Deep	\$192.56
TY25840	Metric 1/2-in. Drive, 12-pt Socket Set, 25-pc; 12mm–32mm Regular; 15mm–22mm Deep	\$188.35
TY19926	SAE 3/4-in. Drive, 12-pt Socket Set, 15-pc; 7/8-in.—1 5/8-in.	\$345.03
TY19986	9-piece SAE 3/4-in. Socket Set with Case; 1 11/16-in.—2 3/8-in.	\$182.11
TY19985	11-piece Metric 3/4-in. Socket Set with Case; 22mm–41mm	\$251.88



Combination Wrenches

Fully polished or satin-finish nickel-chrome plated to resist rust and corrosion.

- A unique radius-corner design that allows contact with the flats, rather than with the points — providing additional torque strength and minimizing fastener rounding
- Stronger — providing less chance of slipping — ideal for frozen or rusted fasteners
- Hot-drop forged from chrome-vanadium alloy steel — ensuring maximum strength and toughness
- Lifetime warranty

NUMBER	DESCRIPTION	LIST
TY27698	3-Piece Metric Combination Wrench Set, Full Polish	\$307.57
TY27696	4-Piece SAE Combination Wrench Set, Full Polish	\$452.83
TY27695	6-Piece SAE Combination Wrench Set, 1 5/16-in.—1 11/16-in., Full Polish	\$396.31
TY27697	6-Piece Metric Combination Wrench Set, Full Polish	\$372.04
TY19922	10-Piece Metric Combination Wrench Set, Satin Finish	\$ 96.95
TY19923	11-Piece Metric Combo Wrench Set, Satin Finish	\$205.83
TY19918	14-Piece SAE Combination Wrench Set, Satin Finish	\$207.89
TY19976	14-Piece SAE Combination Wrench Set, Full Polish	\$241.53
TY19977	20-Piece Metric Combination Wrench Set, Full Polish	\$277.23
TY25249	7-Piece SAE Combination Ratcheting Wrench Set, 3/8-in.—3/4-in.	\$134.97
TY25250	7-Piece Metric Combination Ratcheting Wrench Set, 10mm–17mm	\$139.85



Shop Towels and Absorbents

Start out clean. Toss when done.

Maybe you think that old shop rag of yours is doing the trick, but look at it—it's already dirty. Start fresh each time with John Deere hand towels and absorbents.

NUMBER	DESCRIPTION	LIST
Towels:		
DRC4223	Shop Towels, 200-Count, Box	\$15.50
DRC4601	Shop Towels, 55-Count, Single Roll	\$ 3.50
DRC4221	Shop Towels, 200-Count, Bucket	\$26.00
DRC4222	Shop Towels, 200-Count, Bucket Refill	\$16.50
DRC4602	Shop Towels, 55-Count, Three Pack	\$ 9.50
Absorbent:		
ABS2860	Absorbent Pads, 100-Count, 15-in. x 19-in.	\$46.00
ABS2861	Absorbent Roll, 28.5-in. x 150-ft., Perforated to 15-in. x 19-in. Sheets	\$96.50





HR-20HB-1

HR-20HB-2

Purchase a
20-in. Hand-Carry Toolbox
HR-20HB-1 or HR-20HB-2 and
Receive a **\$10 Rebate.***
*See insert coupon for details.

20-in. Hand-Carry Toolboxes

John Deere hand-carry toolboxes are tough and rugged, built of the highest-quality materials for long wear life and durability. Each offers a 1-year warranty.

NUMBER	DESCRIPTION	LIST
HR-20HB-1	20-in. Toolbox; Powder-Coat Green Finish	\$95.75
HR-20HB-2	20-in. Toolbox; Powder-Coat Green Finish with Yellow Lid	\$95.75



AC-3615RB-G



AC-3015TB-B



AC-3015TB-G



AC-3617TB-G

Road Box & Triangle Toolboxes

The John Deere Road Box features a reinforced security drop-front panel to protect tools from weather and theft. It also includes two bottom-skid rails for additional reinforcement and strength. The unique Triangle Toolboxes keep tools in place and secure in your pickup or Gator. Features include gas strut lid supports and weather stripping seal to protect against dust and moisture.

NUMBER	DESCRIPTION	LIST
AC-3615RB-G	36-in. Green Road Box with 5 Drawers	\$1,060.00
AC-3615RB-B	36-in. Black Road Box with 5 Drawers	\$1,060.00
AC-3015TB-G	30-in. Triangle Toolbox; Green Powder-Coated, Textured Finish	\$ 617.00
AC-3015TB-B	30-in. Triangle Toolbox; Black Powder-Coated, Textured Finish	\$ 617.00
AC-3617TB-G	36-in. Triangle Toolbox; Green Powder-Coated, Textured Finish	\$ 812.00
AC-3617TB-B	36-in. Triangle Toolbox; Black Powder-Coated, Textured Finish	\$ 812.00
AC-2313TB-G	23-in. Triangle Toolbox; Green Powder-Coated, Textured Finish	\$ 514.00
AC-2313TB-B	23-in. Triangle Toolbox; Black Powder-Coated, Textured Finish	\$ 514.00



AC-4624CH-G &
AC-4624CB-G



AC-5625CB-G &
AC-5624H-G

Tool Chests & Cabinets

Keep your tools secure and organized with the John Deere Tool Chests and Cabinets. Powder-coated steel construction includes heavy-duty ball-bearing drawer slides with a load rating of 100-lbs. per pair. Unique raise-and-release drawer fronts keep drawers closed and secure. Tool Chests feature gas strut lid support, and cabinets include oversized polyurethane casters with a 2,000-lb. load rating.

NUMBER	DESCRIPTION	LIST
AC-4624CH-B	46-in. Tool Chest with 8 Drawers; 1,200-lb. Load capacity	\$1,291.00
AC-4624CB-B	46-in. Tool Cabinet with 10 Drawers; 1,400-lb. Load Capacity	\$1,925.00
AC-4624CH-G	46-in. Tool Chest with 8 Drawers; 1,200-lb. Load Capacity	\$1,291.00
AC-4624CB-G	46-in. Tool Cabinet with 10 Drawers; 1,400-lb. Load Capacity	\$1,925.00
AC-5625CB-G	56-in. Tool Cabinet with 10 Drawers; 1,300-lb. Load Capacity with 1 1/4-in. Solid Bamboo Work Surface, 24-in. Depth	\$2,292.00
AC-5624H-G	56-in. Top Hutch with Shelf	\$ 824.00
AC-5625CH-G	56-in. Tool Chest with 8 Drawers; 800-lb. Load Capacity	\$1,571.00
AC-7224CB-G	72-in. Tool Cabinet with 15 Drawers; 1,600-lb. Load Capacity with 1 1/4-in. Stainless steel Work Surface, 24-in. depth	\$3,810.00
AC-7224H-G	72-in. Top Hutch with Shelf	\$1,085.00

SLICK

IN MORE WAYS THAN ONE

Whether you pour it or pump it, there's **no better choice** than specially formulated Plus-50™ II Engine Oil for all your John Deere **agricultural equipment**. And it also works like a champ to protect and lubricate other engines on the farm. Like **semi** and **pickup trucks**, **Gators** and **riding lawn mowers**. Even portable **air compressors**, **generators** and **power washers**.

So reach for Plus-50 II often. It's the one engine oil for just about everything.

On the farm. In the field. On the highway.

**AVAILABLE IN SMALL CONTAINERS OR BULK.
CONTACT US TODAY.**



SCAN TO
WATCH VIDEO



JOHN DEERE

JohnDeere.com/Oil

PRESORTED STANDARD
U.S. POSTAGE PAID
Maple Grove, MN
PERMIT NO. 584

PARTS & SERVICE FINANCING – ON YOUR TERMS

HARVEST TERMS™

PARTS, SERVICE, INSPECTIONS

- Buy Now, Pay After Harvest 2025
- Interest Free Financing
- Improved Cash Flow & Savings

Subject to program availability, approved credit on a Multi-Use Account™ and merchant participation. Certain restrictions and conditions apply.



Scan to get your HARVEST TERMS™ offer.

If your address is incorrect, please correct (show any desired change in name and address, including street, route, box number, zip code).
Clip this page including dealer imprint(s) above and send to: John Deere, P.O. Box 410418, Kansas City, MO 64141-0418



JDParts.JohnDeere.com

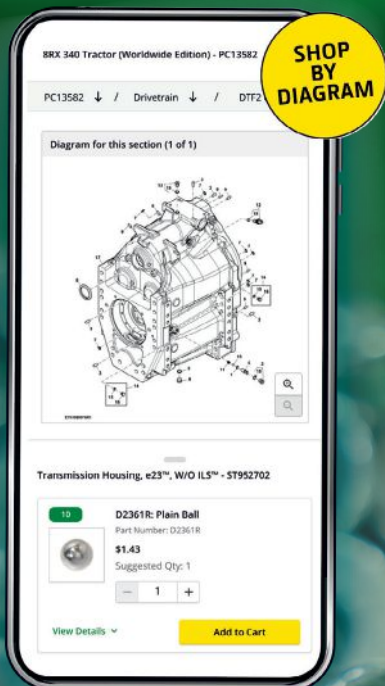

SHOP BY DIAGRAM

We've Got You

Finding Your Parts is Easy

- + Select Equipment to Shop by Diagram
- + Search for Parts that Fit Your Equipment
- + Shop Your Dealer Online

Visit Shop.Deere.com and Get Started!

